



# Wholesale Supplier ENT (Ear & Throat) -ORAL\_Instrument A to Z Hospital Equipment and Surgical Products **B to C**

## ENT-ORAL



Scissors .....	706 - 708
Needles .....	709
Forceps .....	709 - 712
Clamps .....	713 - 719
Tracheal Dilators / Hooks / Retractors .....	720 - 721
Retractors .....	722 - 724
Tonsil Dissectors .....	725
Adenotomes, Tonsil Snares and Wires .....	726 - 728
Mouth Gags .....	729 - 737
Tonsil Knives .....	738
Suction Tubes .....	739
Adenoid Curettes .....	740 - 742
Syringes .....	743
Laryngeal Mirrors .....	744
Amalgam Carriers .....	745

**8275140877**

**9822688071**

**info@amramedtech.com**



**Sr No.29/1/2, Adarsh Nagar,  
Uruli Devachi, Hadapsar, Pune  
Branches :- All Maharashtra**



**amramedtech.com**



**ENT-ORAL ORAL SCISSORS**

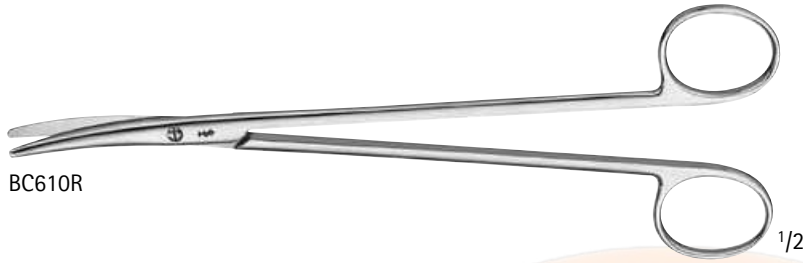

**LILLIE Dissecting Scissors**

Catalog Number	Tip	Blade	Length (in.)
BC610R	B/B	CVD	7 7/8



**DEAN Tonsil Scissors**

Catalog Number	Tip	Blade	Length (in.)
OM700R	B/B	ANG-SERR	6 3/4

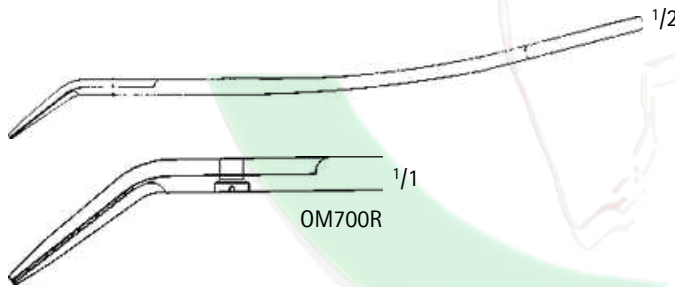

**BOETTCHER Tonsil Scissors**

Catalog Number	Tip	Blade	Length (in.)
OM707R	B/B	CVD	7

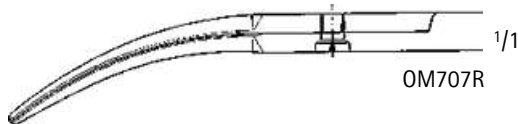



**ENT-ORAL ORAL SCISSORS**

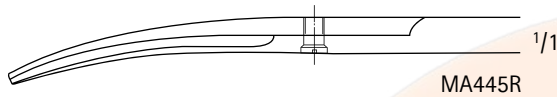

**BROPHY Gum Scissors**

Catalog Number	Tip	Blade	Length (in.)
MA445R	S/S	CVD	5 1/2

**DUROTIP™ Tungsten Carbide Scissors**  
 ■ Excellent cutting accuracy ■ Long working life ■ Gold-plated rings

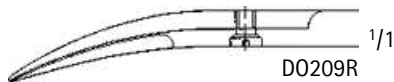
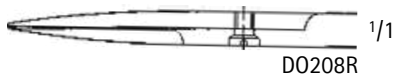

**DUROTIP TC Gum Scissors, Delicate**

Catalog Number	Tip	Blade	Length (in.)
D0208R	S/S	STR	4 3/4
D0209R	S/S	CVD	4 3/4





**ENT-ORAL LARYNGEAL SCISSORS**

**Micro Laryngeal Scissors, W/ Flush Port**

Catalog Number	Tip	Blade	Working Length (in.)
OP310R	S/S	STR	9 3/4
OP311R	S/S	CVD-LEFT	9 3/4
OP312R	S/S	CVD-RIGHT	9 3/4
OP313R	S/S	ANG-UP	9 3/4

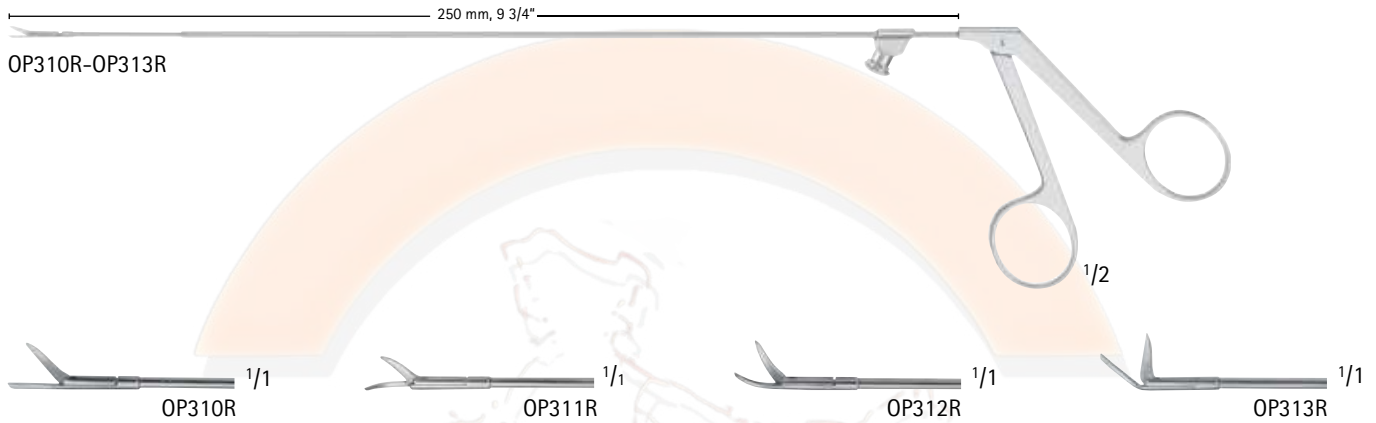

**KLEINSASSER Micro Scissors**

Catalog Number	Tip	Blade	Blade Size (mm)	Working Length (in.)
MA460R	B/B	STR	4	14





**ENT-ORAL NEEDLES AND FORCEPS**

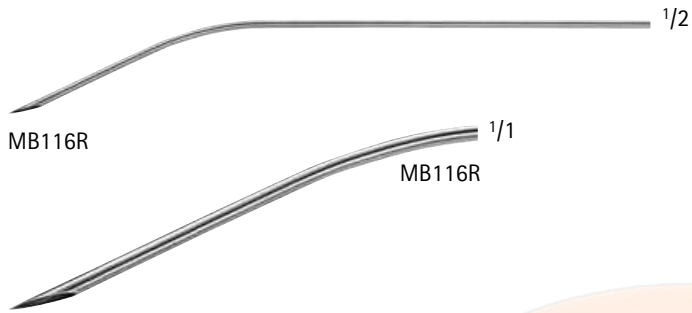

**DINGMAN Wire Passing Needle**

Catalog Number	Tip	Length (in.)
MB116R	CVD	6 3/4

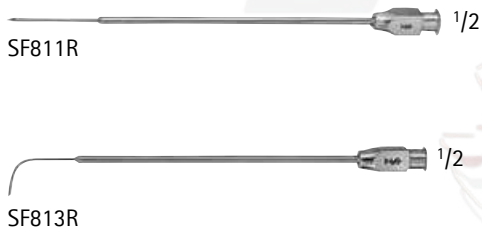

**Tonsil Needle, 23 Gauge**

Catalog Number	Tip	Tip Size (mm)	Length (in.)
SF811R	STR	DIAM. 0.8	3
SF813R	CVD	DIAM. 0.8	3

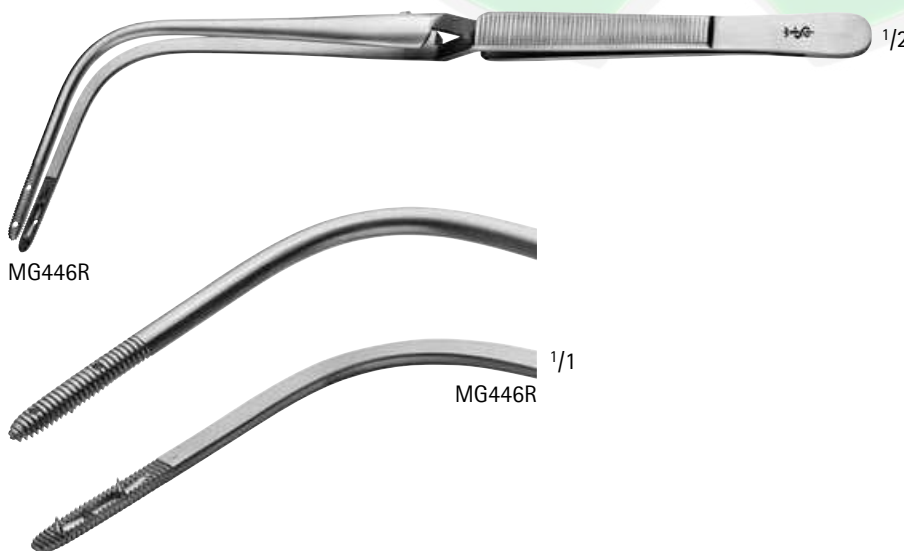

**JACKSON Laryngeal Self-Closing Dressing Forceps**

Catalog Number	Tip	Teeth	Length (in.)
MG446R	SERR	1 x 2	9





**ENT-ORAL FORCEPS**

**Laryngeal Forceps, W/ Flush Port**

Catalog Number	Jaw	Working Length (in.)
OP300R	STR	9 3/4
OP301R	CVD-LEFT	9 3/4
OP302R	CVD-RIGHT	9 3/4

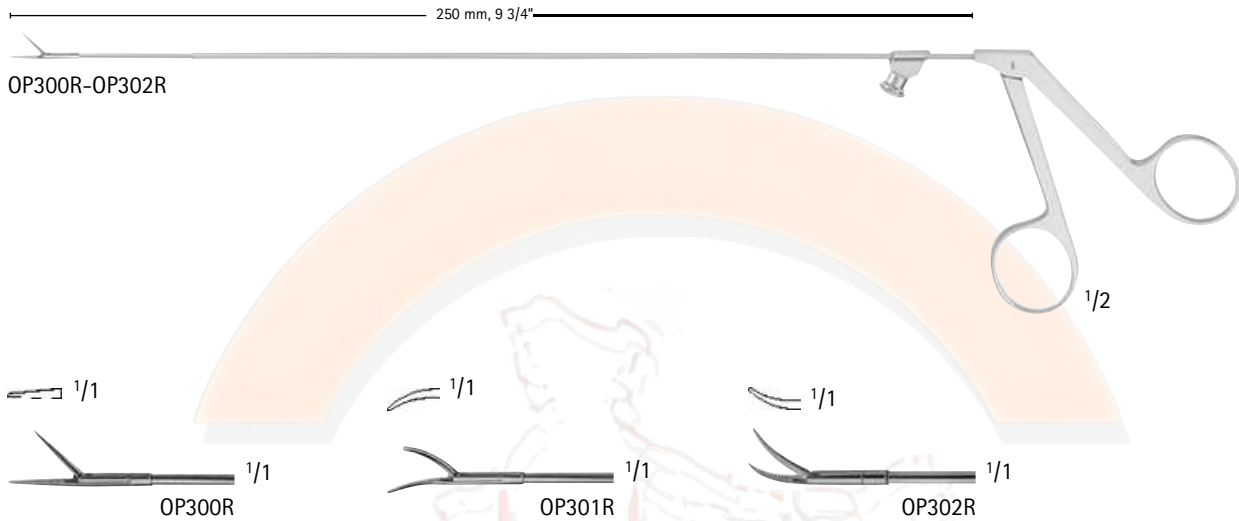

**Micro Laryngeal Cup Forceps, W/ Flush Port**

Catalog Number	Cup Size (mm)	Jaw	Working Length (in.)
OP304R	2	STR	9 3/4
OP305R	2	ANG-LEFT	9 3/4
OP306R	2	ANG-RIGHT	9 3/4
OP307R	2	ANG-UP	9 3/4

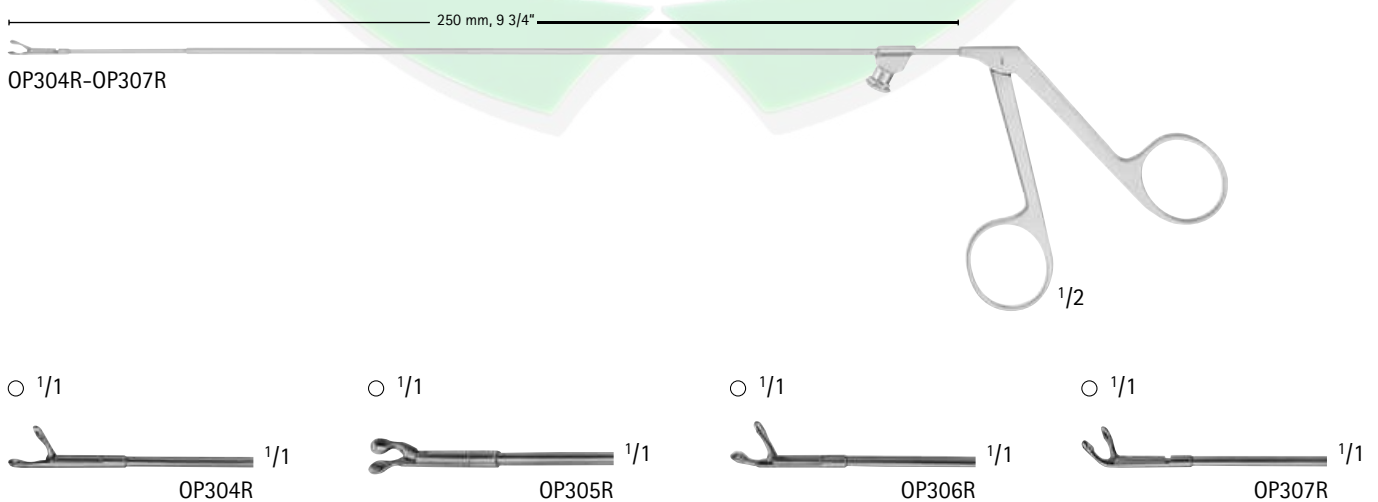



**AMRAMED**<sup>®</sup>  
TECH Pvt. Ltd.

**Wholesale Supplier**

A to Z Hospital Equipment and  
Surgical Products B to C



**Certified Register**

**ENT-ORAL FORCEPS**

Alligator Grasping Forceps

Catalog Number	Tip	Tip Size (mm)	Working Length (in.)	Length (in.)
MA663R	SERR	8.8 x 4	11	13 3/4

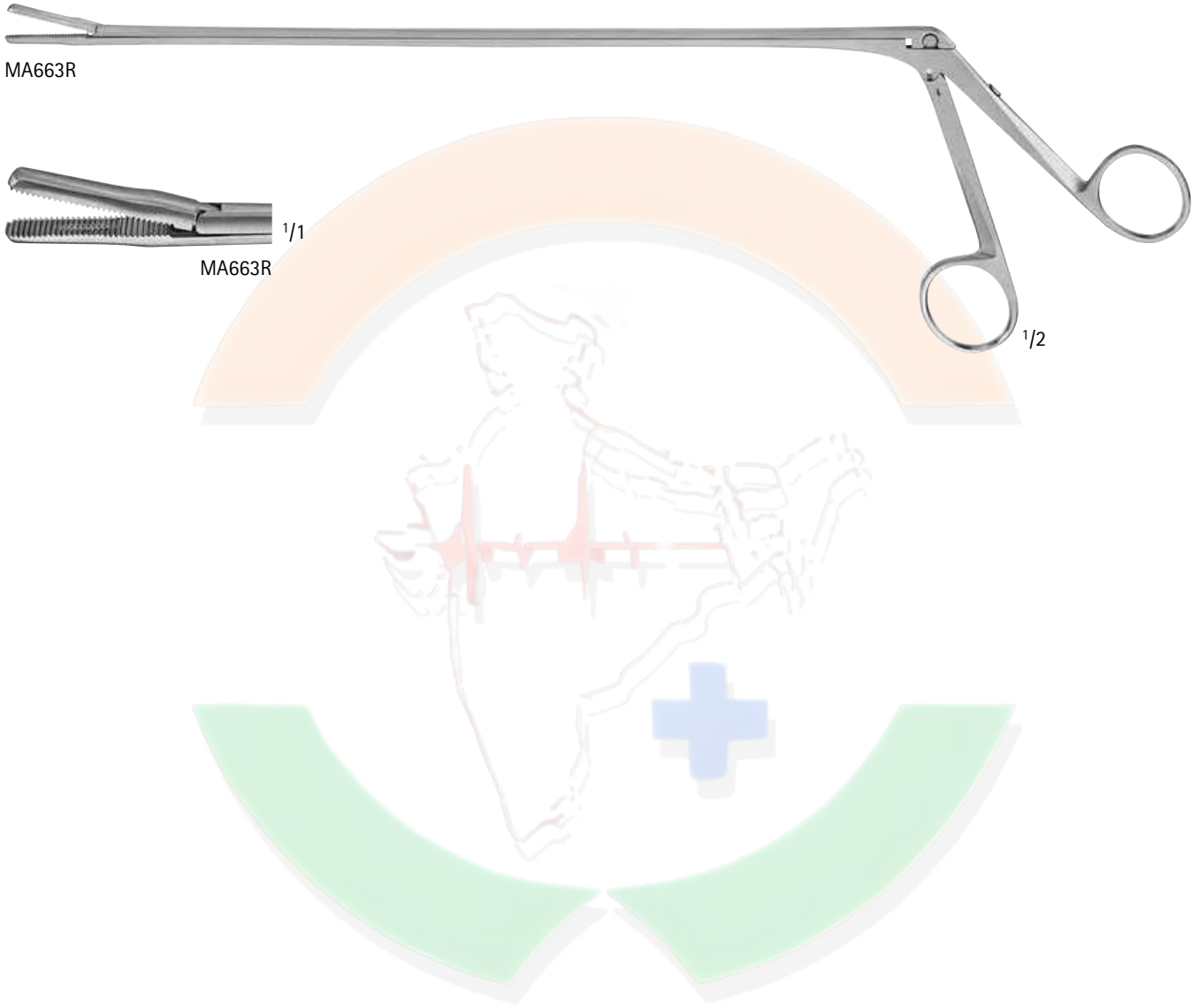

MA663R



MA663R

1/2





**ENT-ORAL FORCEPS**

**ST CLAIR Adenoid Forceps**

Catalog Number	Length (in.)
MA645R	7 1/2

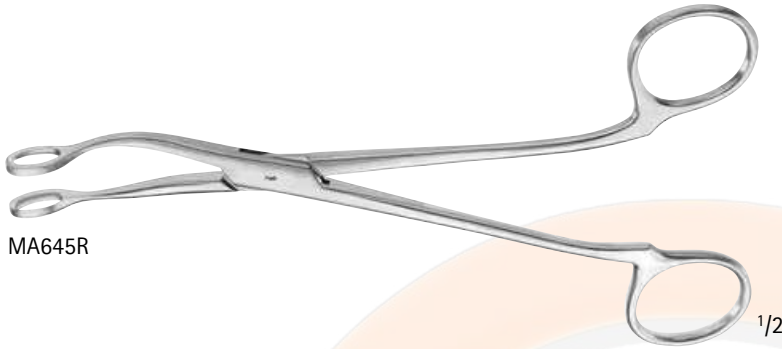

MA645R

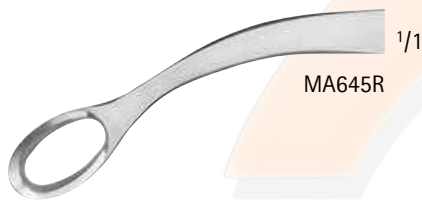

MA645R

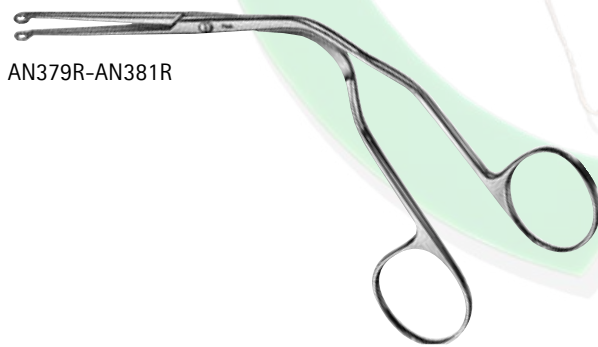

AN379R-AN381R

**MAGILL Forceps**

Catalog Number	Size	Length (in.)
AN379R	INFANT	6
AN380R	PEDIATRIC	7 7/8
AN381R	ADULT	9 3/4



AN379R

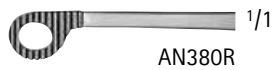

AN380R



AN381R





**ENT-ORAL CLAMPS**

**SCHNIDT Tonsil Clamp**

Catalog Number	Ring Handle	Jaw	Length (in.)
MA172R	OPEN RING	STR	7 1/2
BH961R	OPEN-RING	SLIGHT-CVD	7 1/4
BH963R	OPEN-RING	CVD	7 1/4
BH957R	CLOSED-RING	SLIGHT-CVD	7 1/4
BH959R	CLOSED-RING	CVD	7 1/4

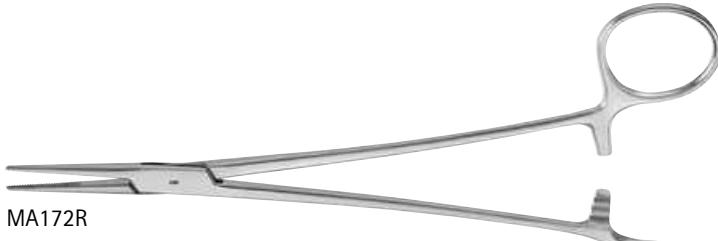

MA172R



MA172R

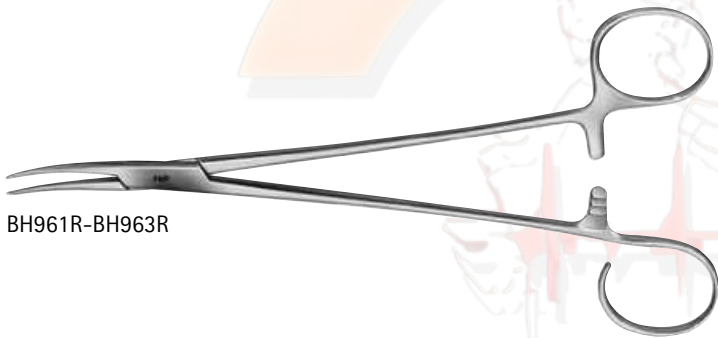

BH961R-BH963R



BH961R



BH963R

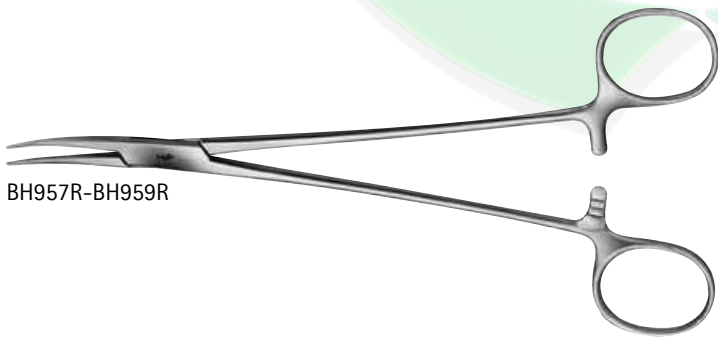

BH957R-BH959R



BH957R



BH959R

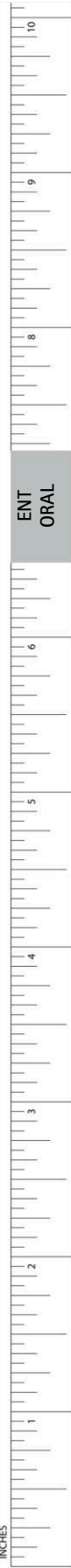



**ENT-ORAL CLAMPS**

**Tonsil Clamp, X-long**

Catalog Number	Jaw	Length (in.)
MB103R	CVD	14 1/2

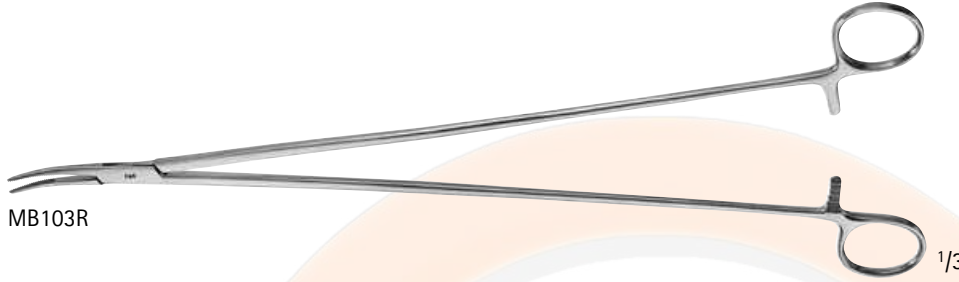

MB103R

1/3



MB103R

1/1

**ADSON Tonsil Clamp, Delicate**

Catalog Number	Jaw	Length (in.)
BH200R	STR	7 1/4
BH201R	CVD	7 1/4

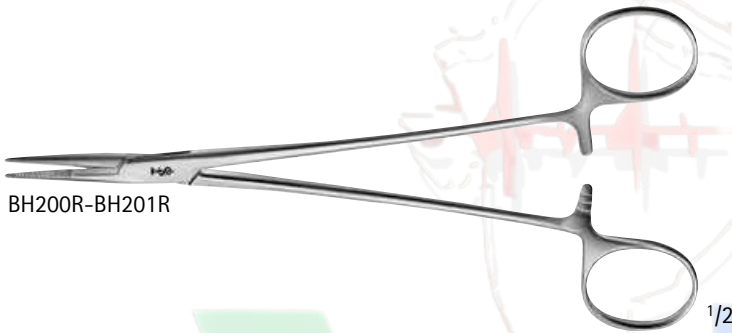

BH200R-BH201R

1/2



BH200R

1/1

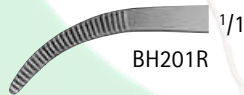

BH201R

1/1

**NISSEN Tonsil Clamp, Delicate**

Catalog Number	Jaw	Length (in.)
BH199R	CVD	7 1/4

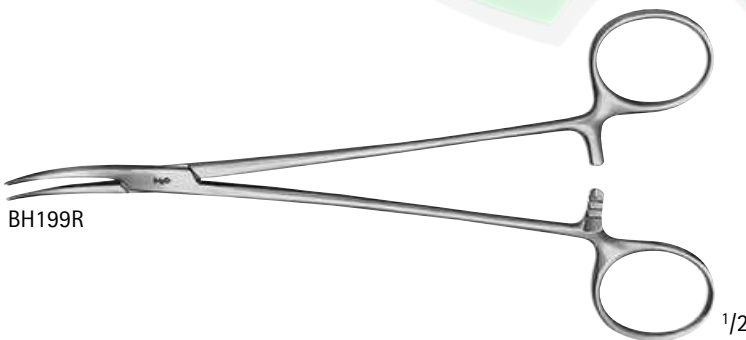

BH199R

1/2

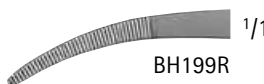

BH199R

1/1



**ENT-ORAL CLAMPS**

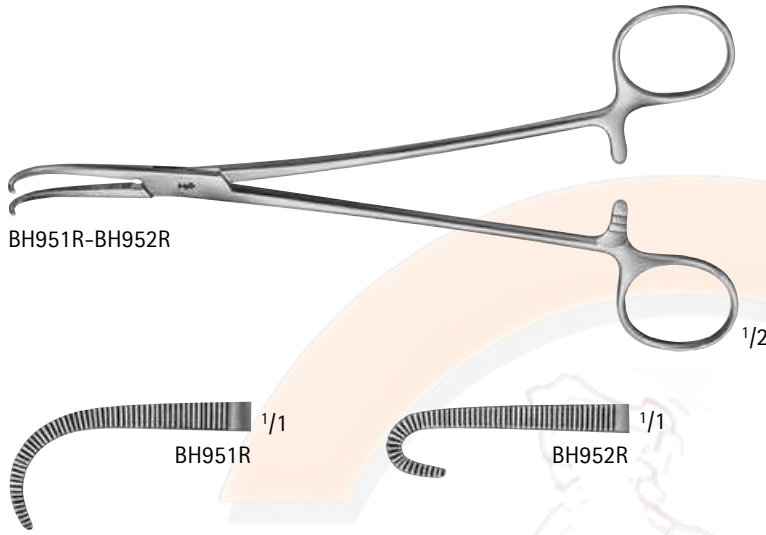

**NEGUS Tonsil Clamp**

Catalog Number	Jaw	Length (in.)
BH951R	HEAVY-CVD	7 1/2
BH952R	U-CVD	7 1/2

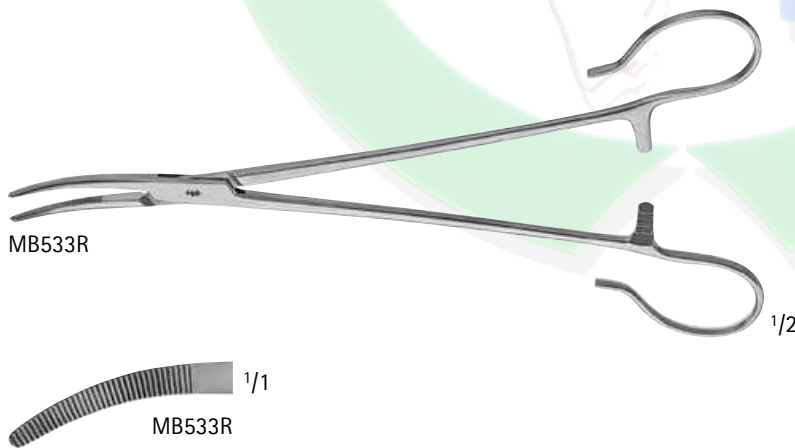

**MCHENRY Tonsil Artery and Sponge Holding Clamp**

Catalog Number	Jaw	Length (in.)
MB533R	CVD	8





**ENT-ORAL CLAMPS**

**MUSEUX Tonsil Clamp**

Catalog Number	Tip	Length (in.)
OM602R	2 x 2	7 7/8



OM602R

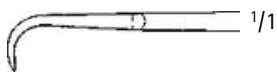

1/1



OM602R

**WHITE Tonsil Seizing Clamp**

Catalog Number	Length (in.)
OM612R	7
OM613R	9 1/4



OM612R

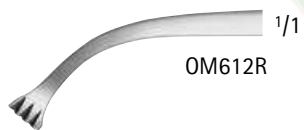

OM612R



OM613R

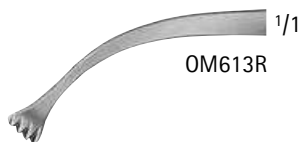

OM613R

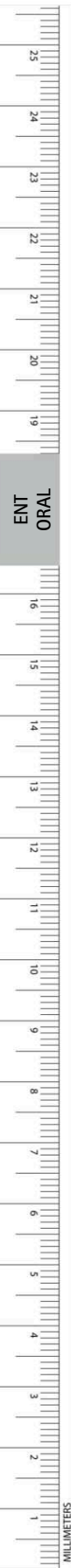

**ENT-ORAL CLAMPS**

**ALLIS-COAKLEY Tonsil Clamp**

Catalog Number	Jaw	Length (in.)
MA539R	STR	7 7/8
MA540R	STRONG CVD	7 5/8



MA539R



MA539R



MA540R



MA540R



OM611R

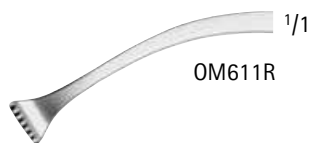

OM611R

**COLVER Tonsil Seizing Clamp**

Catalog Number	Length (in.)
OM611R	7 7/8





**AMRAMED**  
TECH Pvt. Ltd.

**Wholesale Supplier**

A to Z Hospital Equipment and  
Surgical Products B to C



**Certified Register**

**ENT-ORAL CLAMPS**

**COLLIN Tongue Clamp**

Catalog Number	Jaw	Length (in.)
BH906R	OVAL	6 1/4

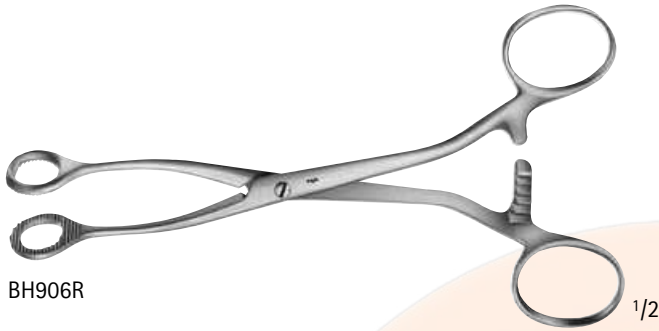

BH906R

1/2

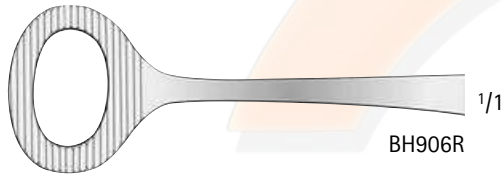

BH906R

1/1

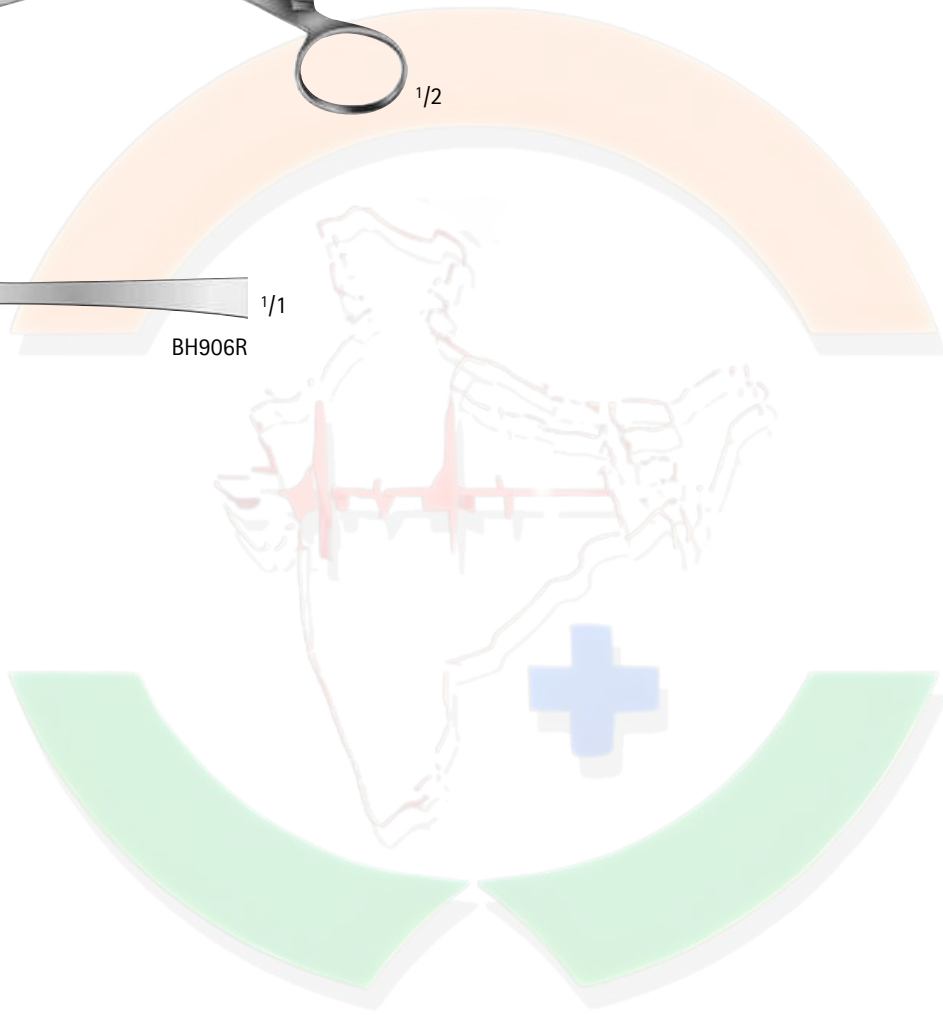



**ENT-ORAL CLAMPS**

**HEYWOOD-SMITH Tongue Clamp**

Catalog Number	Tip	Length (in.)
AN710R	SERR	7 7/8
AN711R	SERR	8 1/4

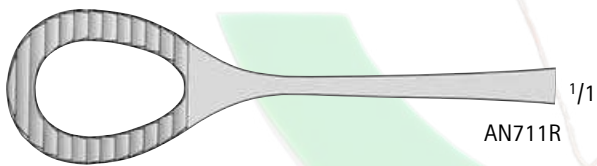
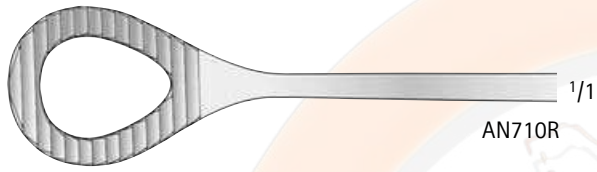
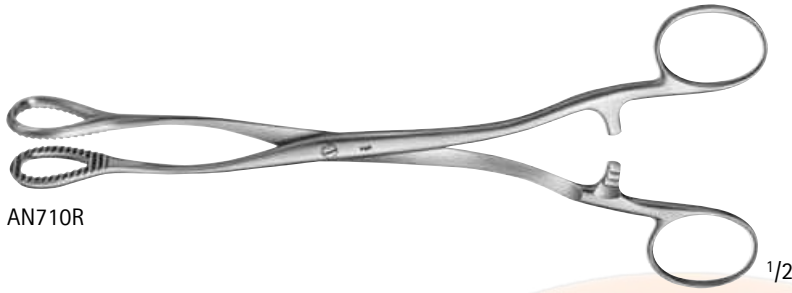



**ENT-ORAL TRACHEAL DILATORS/HOOKS/RETRACTORS**



FA025R

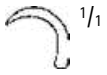

FA026R

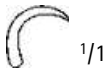

**BOSE Tracheal Hook**

Catalog Number	Tip	Length (in.)
FA025R	CVD-LEFT	6 1/2
FA026R	CVD-RIGHT	6 1/2



BT103R-BT107R

**Tracheal Retractor**

Catalog Number	Tip	Blade End	Length (in.)
BT103R	SHARP	1 PRONG	7
BT106R	BLUNT	1 PRONG	7
BT107R	BLUNT	2 PRONGS	7



BT103R



BT106R



BT107R



MB230

**JACKSON Tracheal Retractor**

Catalog Number	Length (in.)
MB230	7



1/1



MB230

1/1





**ENT-ORAL TRACHEAL DILATORS/HOOKS/RETRACTORS**



FA005R

**TROUSSEAU Tracheal Dilator**

Catalog Number	Length (in.)
FA005R	4 3/4

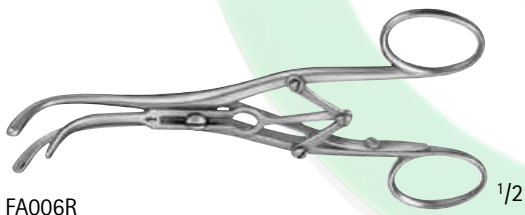

FA006R

**LABORDE Tracheal Dilator**

Catalog Number	Length (in.)
FA006R	5
FA007R	5 1/4



FA007R

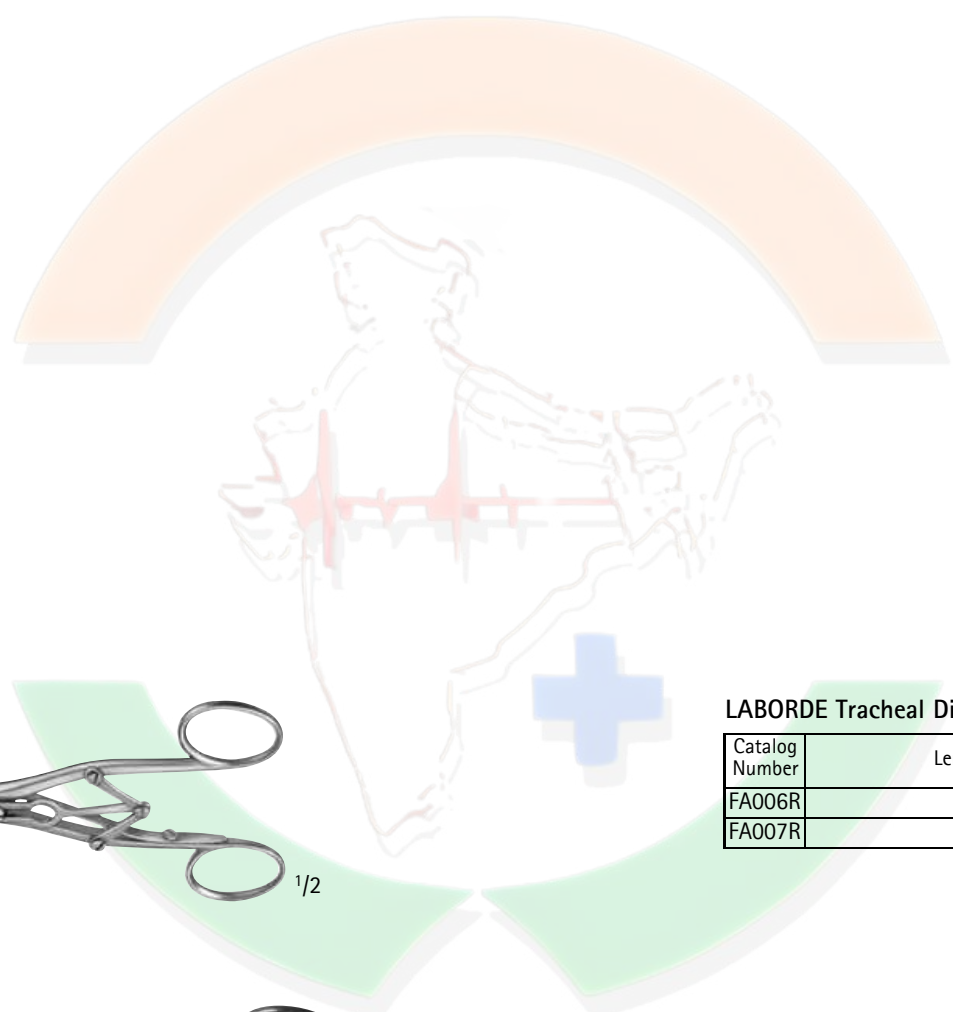



**ENT-ORAL RETRACTORS**

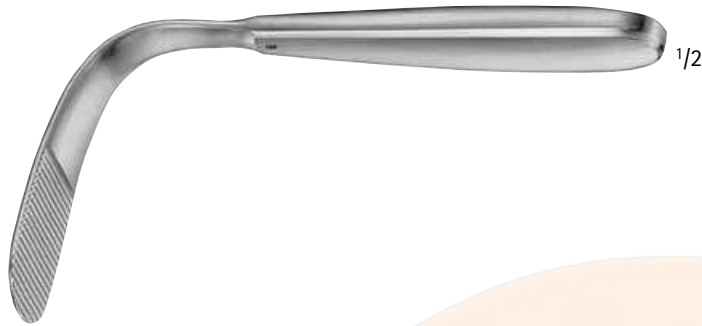
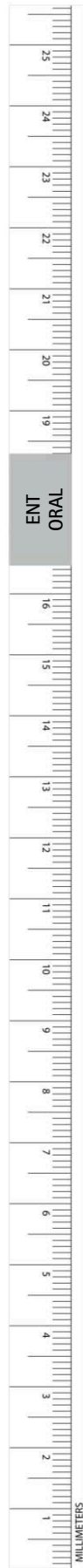

OM235R

**TOBOLD Tongue Depressor**

Catalog Number	Length (in.)
OM235R	6 1/4



OM236R-OM237R

**WEDER Tongue Depressor**

Catalog Number	Size	Length (in.)
OM236R	SMALL	5
OM237R	LARGE	5

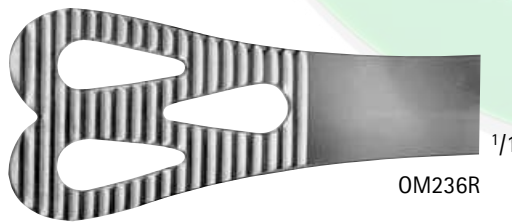
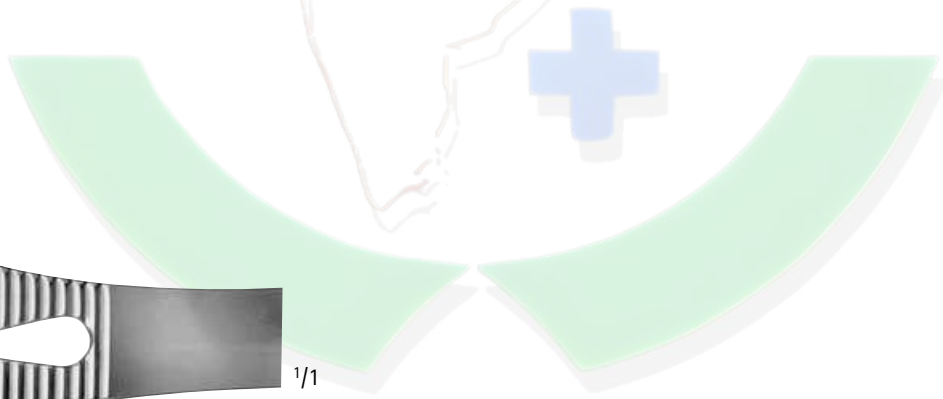

OM236R

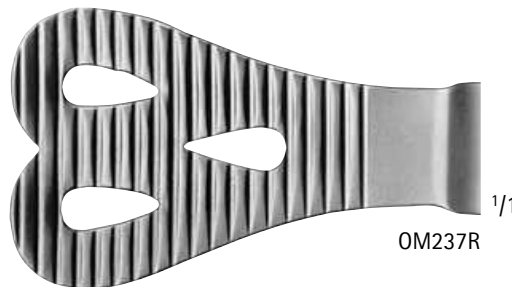

OM237R



**ENT-ORAL RETRACTORS**

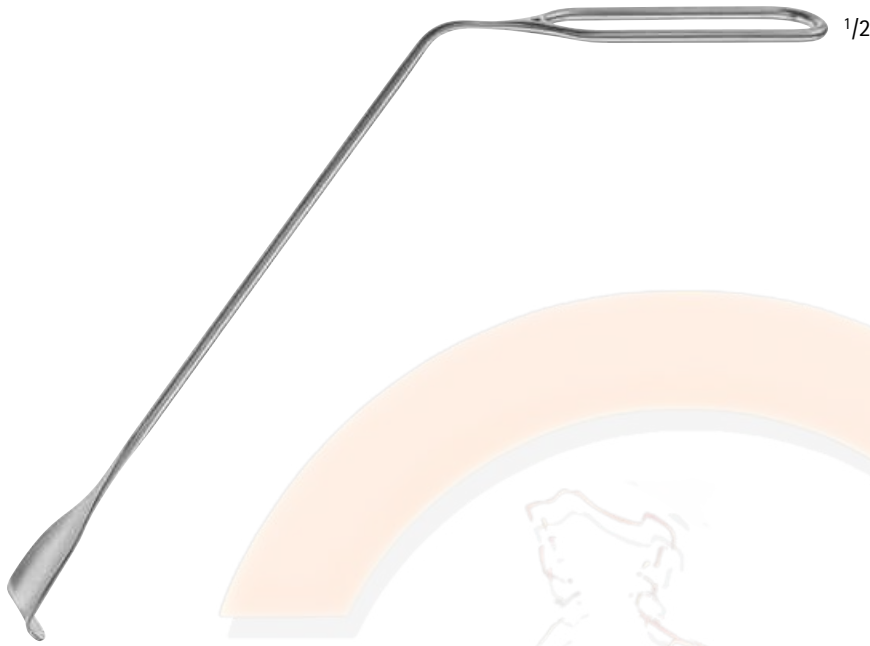

MA719R

**LOTHROP Uvula Retractor**

Catalog Number	Blade Size (mm)	Length (in.)
MA719R	17 x 20	9 5/8



MA719R



MA608R

**GOODYEAR Uvula Retractor**

Catalog Number	Blade Size (mm)	Length (in.)
MA608R	15	7 3/8



MB785R

**LAHEY Goiter Retractor**

Catalog Number	Blade Size (mm)	Length (in.)
MB785R	24 x 8	7 7/8



MB785R





**ENT-ORAL RETRACTORS**

**SEWALL Orbital Retractor**

Catalog Number	Blade Size (mm)	Length (in.)
MA434R	7 x 52	6 3/4
MA435R	9 x 44	6 3/8
MA436R	11 x 50	6 3/8
MA437R	13 x 67	6 3/4



MA434R-MA437R



MA434R

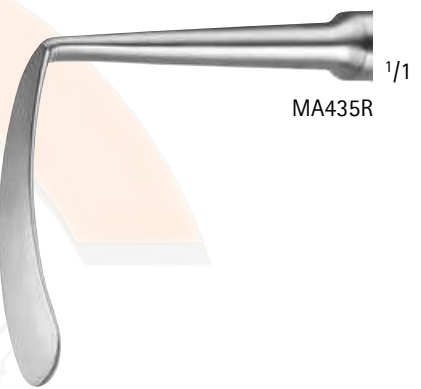

MA435R



MA436R

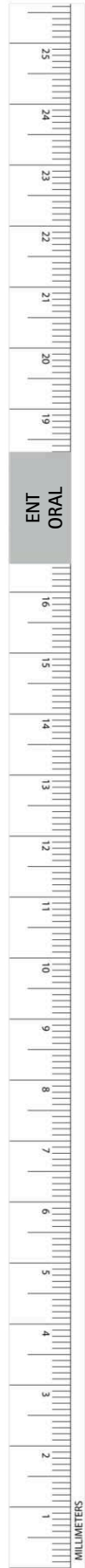

ENT  
ORAL

MILLIMETERS



**ENT-ORAL TONSIL DISSECTORS**

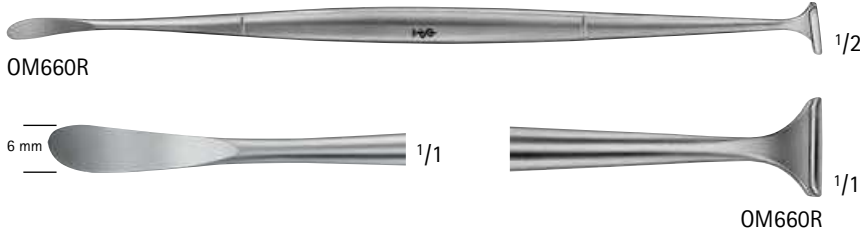

**HURD Tonsil Dissector / Pillar Retractor**

Catalog Number	Tip Size (mm)	Length (in.)
OM660R	6	8 1/2
OM661R	10	8 1/2



**HENKE Tonsil Dissector**

Catalog Number	Tip Size (mm)	Length (in.)
OM668R	12	9 1/4

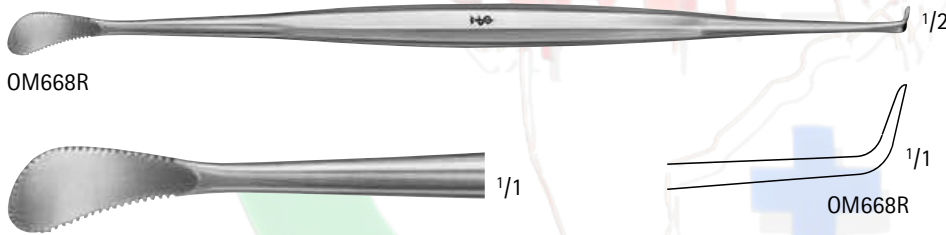

**LOTHROP Tonsil Knife and Dissector**

Catalog Number	Length (in.)
MA289R	8 1/4





**ENT-ORAL ADENOTOMES/TONSIL SNARES/WIRES**



OM391R-OM398R

1/2

**LA FORCE Adenotome**

Catalog Number	Size (#)	Description	Length (in.)
OM391R	1	-	9 1/4
OM392R	2	-	9 1/4
OM393R	3	-	9 1/4
OM396R	-	SPARE BLADE F/ OM391R	-
OM397R	-	SPARE BLADE F/ OM392R	-
OM398R	-	SPARE BLADE F/ OM393R	-



OM396R



1/1

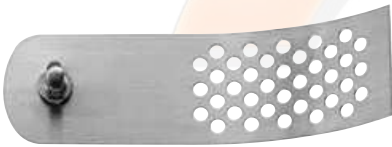

OM397R



1/1

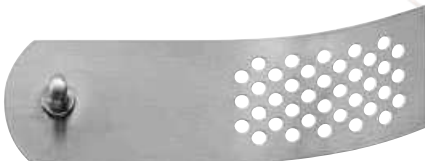

OM398R



1/1

**EVES Tonsil Snare W/ 25 Gauge Wire**

Catalog Number	Description	Length (in.)
OM760R	W/O RATCHET	9 3/4
OM761R	W/ RATCHET	9 3/4



OM760R

1/2



OM761R

1/2



**ENT-ORAL ADENOTOMES/TONSIL SNARES/WIRES**

**LEWIS Tonsil Snare**

Catalog Number	Description	Length (in.)
MA714R	INCLUDES 12 #8 SNARE WIRES	10 1/4

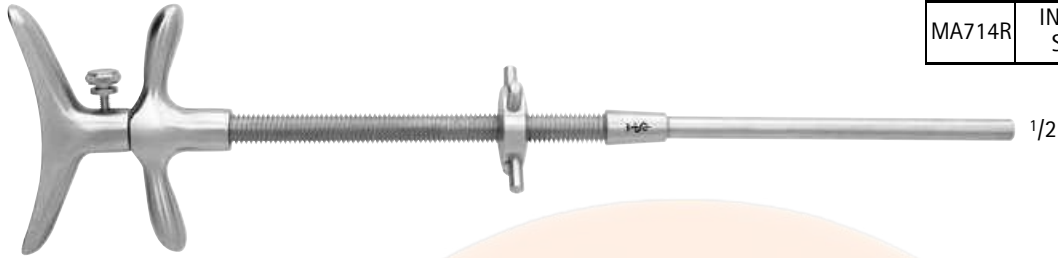

MA714R



**SAGE Tonsil Snare**

Catalog Number	Description	Length (in.)
MA493R	W/ SNARE WIRES	11
MA490R	2 #6 SNARE WIRES	4

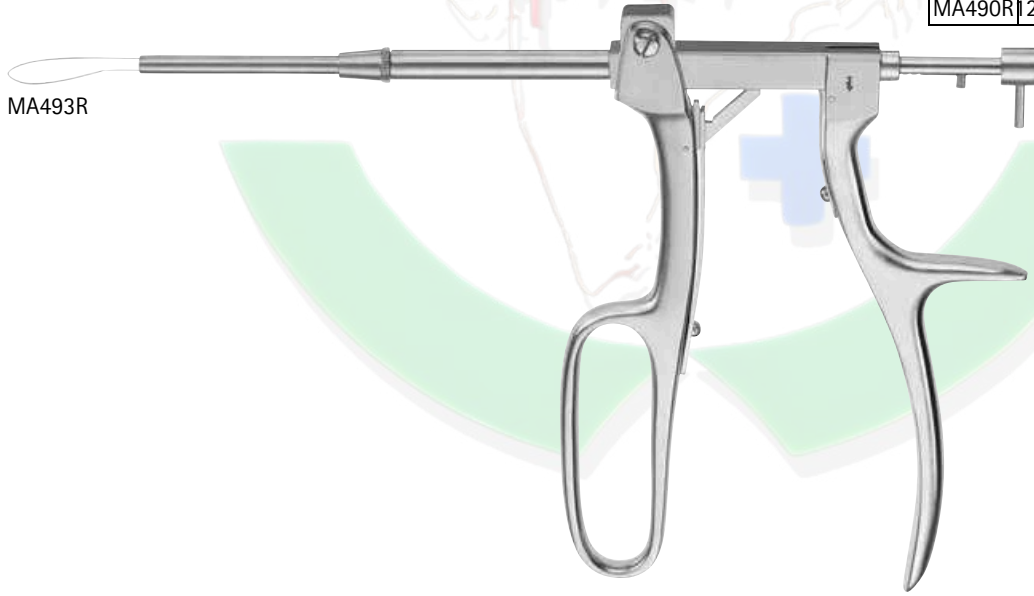

MA493R

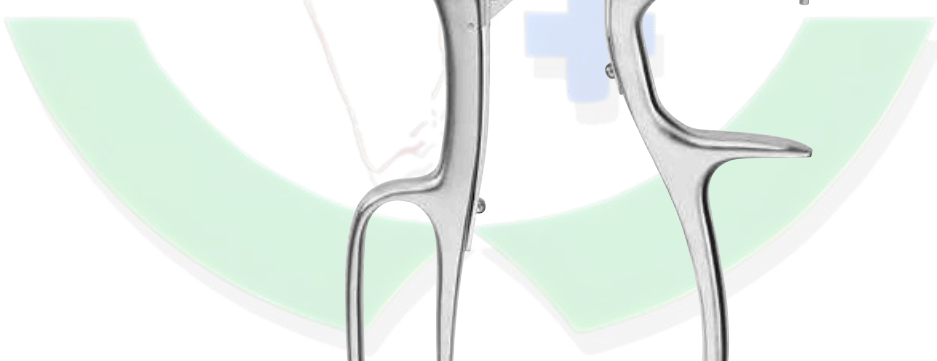

1/2



MA490R

1/4





**ENT-ORAL TONSIL SNARES/WIRES/ADENOTOMES**

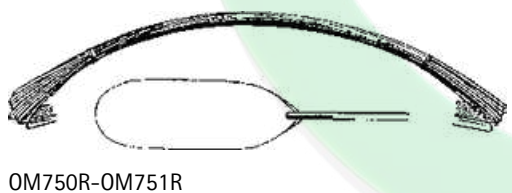
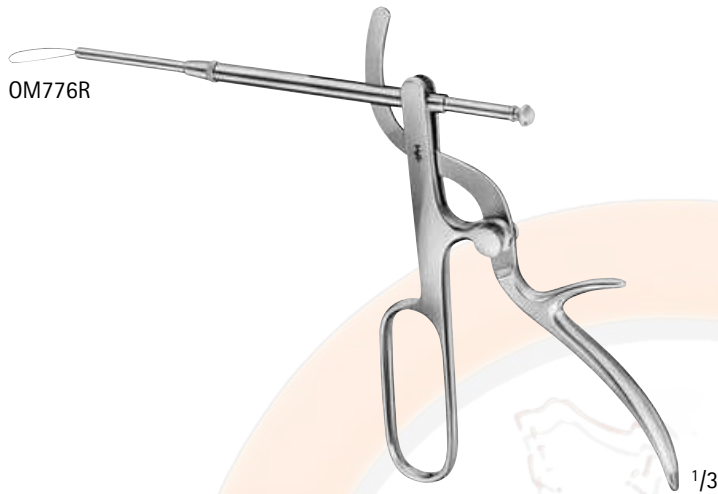
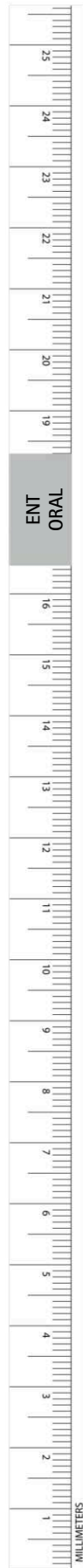

OM750R-OM751R



MA490R

**TYDING Tonsil Snare**

Catalog Number	Description
OM781R	-
OM776R	TIP ONLY, STR

**Tonsil Snare Wire**

Catalog Number	Diameter (mm)	Size (#)	Sales Unit	Length (mm)
MA490R	1.4	6	12/BOX	100
OM750R	0.3	7	12/BOX	100
OM751R	0.5	8	12/BOX	100





**ENT-ORAL MOUTH GAGS**

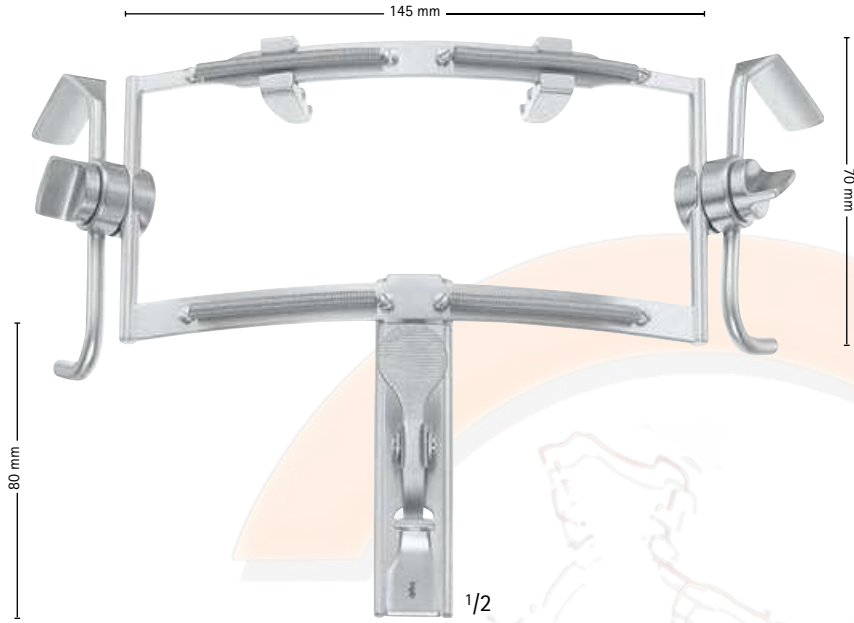

MA299R



OM038R



OM040R, TA009706

**DINGMAN Mouth Gag**

Catalog Number	Description
MA299R	COMPLETE SET WITH 3 BLADES AND FRAME

MA299R Includes:

- 1 Mouth Gag OM105R,
- 1 Blade of each OM171R, OM172R, OM177R

**MOLT Mouth Gag, Pediatric**

Catalog Number	Description	Length (in.)	Length (m)
OM038R	-	4	-
TA009706	SPARE SILICONE TUBE ONLY, LATEX-FREE	-	1

TA009706 Protective covers for OM038R and OM040R available as silicone tubing which may be cut to length

**DOYEN-COLLIN Mouth Gag**

Catalog Number	Description	Length (in.)	Length (m)
OM040R	-	4 3/4	-
TA009706	SPARE SILICONE TUBE ONLY, LATEX-FREE	-	1

TA009706 Protective covers for OM038R and OM040R available as silicone tubing which may be cut to length





**ENT-ORAL MOUTH GAGS**

**DOYEN-JANSEN Mouth Gag**

Catalog Number	Description	Length (in.)	Length (m)
OM041R	-	5 1/2	-
TA005771	SPARE SILICONE TUBE ONLY, LATEX-FREE	-	1

TA005771 Protective covers for OM041R available as silicone tubing which may be cut to length

**DENHARDT Mouth Gag**

Catalog Number	Length (in.)
OM047R	5

**WHITEHEAD-JENNINGS Mouth Gag**

Catalog Number	Length (in.)
OM070R	3 1/2
OM071R	4 1/4
OM072R	5 1/8
OM073R	6

**Teeth Protector, Latex-Free Rubber**

Catalog Number	Size
OP299	ADOLESCENT AND ADULT



OM041R, TA005771

1/2



OM047R

1/2

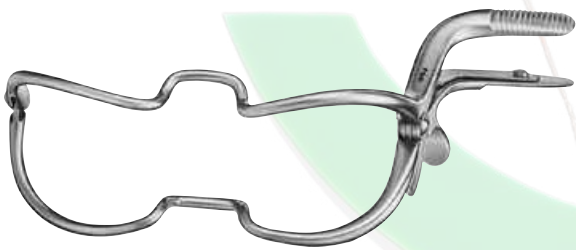

OM070R-OM073R



OP299

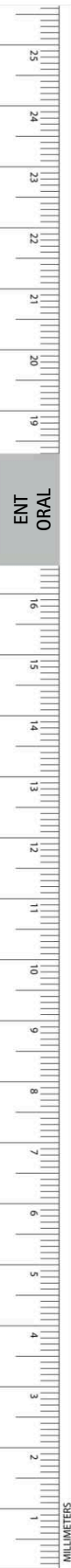



**ENT-ORAL MOUTH GAGS**



MA307R



MA304R



MA305R



MA306R



MA308R



OM170

**DAVIS Mouth Gag**

Catalog Number	Blade Size (mm)	Size (#)	Description	Length (in.)
MA302R	-	-	COMPLETE SET, RIGHT	-
MA303R	-	-	COMPLETE SET, LEFT	-
MA307R	-	-	RIGHT FRAME ONLY	6
MA304R	20 x 34	1	BLADE	5 1/4
MA305R	23 x 64	2	BLADE	5 1/4
MA306R	25 x 79	3	BLADE	5 1/4
MA308R	25 x 85	3 1/2	BLADE	5 1/8
MA309R	25 x 95	4	BLADE	5 1/8
MA310R	25 x 106	5	BLADE	5 1/8
OM170	SILICONE INSERT			

**MA302R Includes:**

1 Blades w/ Tube of each MA304R, MA307R, OM112R, MA315R, OM114R, OM115R

**MA303R Includes:**

1 Blades w/ Tube of each OM116R, MA304R, OM112R, MA315R, OM114R, OM115R



MA309R



MA310R





**AMRAMED**<sup>®</sup>  
TECH Pvt. Ltd.

**Wholesale Supplier**

A to Z Hospital Equipment and  
Surgical Products B to C



**Certified Register**

**ENT-ORAL MOUTH GAGS**

**DAVIS Mouth Gag W/ Tube**

Catalog Number	Blade Size (mm)	Size (#)
MA315R	24 x 80	3
MA319R	25 x 90	3



MA315R



MA319R

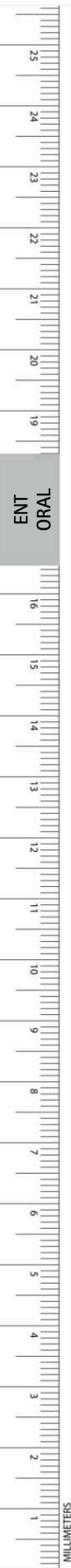
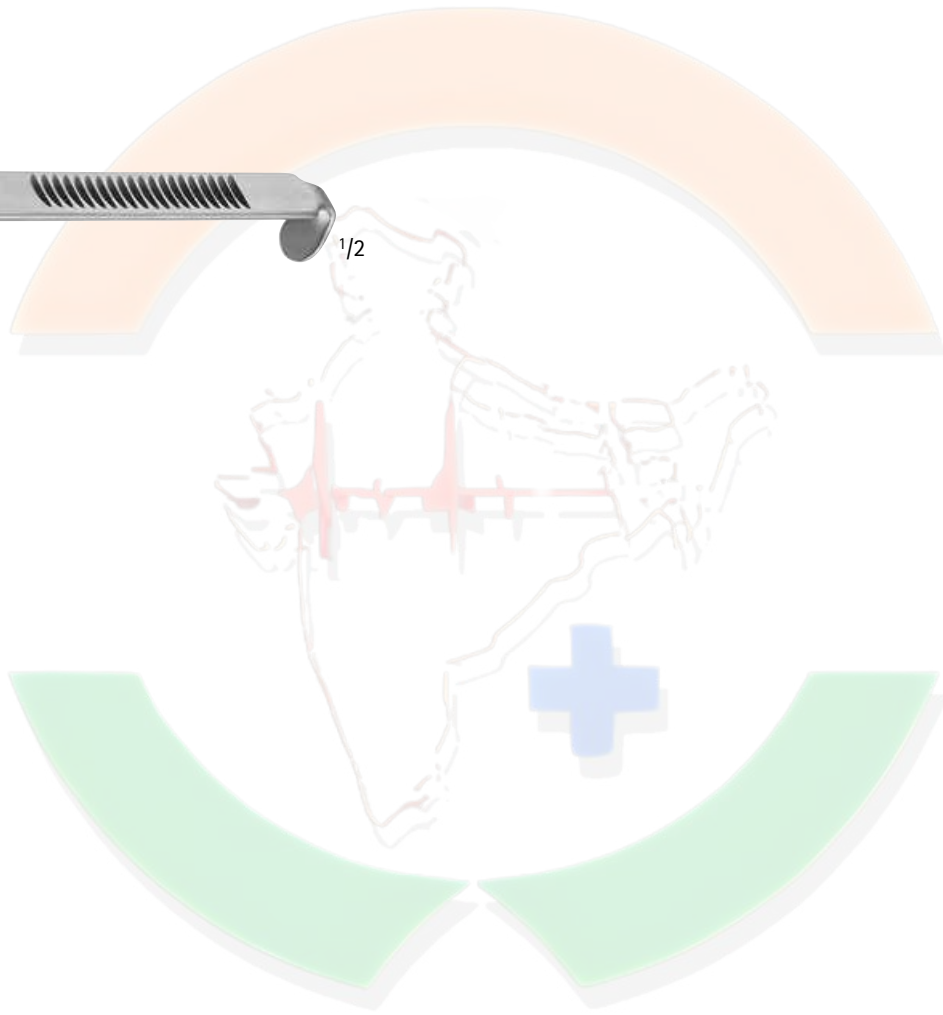



**ENT-ORAL MOUTH GAGS**

**DAVIS-BOYLE Mouth Gag**

Catalog Number	Blade Size (mm)	Size	Description	Length (in.)
OM118R	OM119R	CHILD	FRAME ONLY	5 1/4
OM116R	-	TEEN	FRAME ONLY	5 3/4
OM112R	25 x 62	ADULT	FRAME ONLY	6 3/4
OM113R	25 x 75	-	BLADE	-
OM114R	25 x 92	-	BLADE	-
OM115R	25 x 108	-	BLADE	-
OM170	-	-	SILICONE INSERT	-

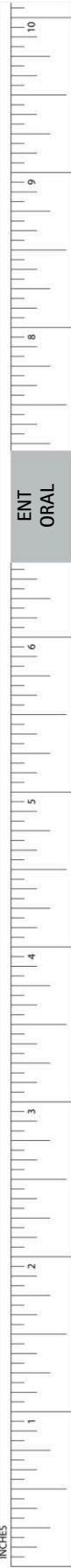
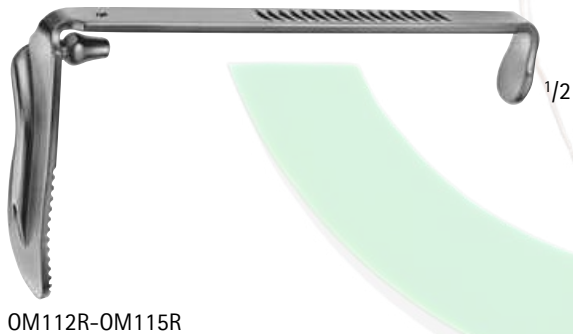



**ENT-ORAL MOUTH GAGS**

**DAVIS-MEYER Tongue Depressor Frame**

Catalog Number	Description
OM169R	FRAME, COMPLETE
OM170	SILICONE INSERT
OM179R	PALATE BLADE

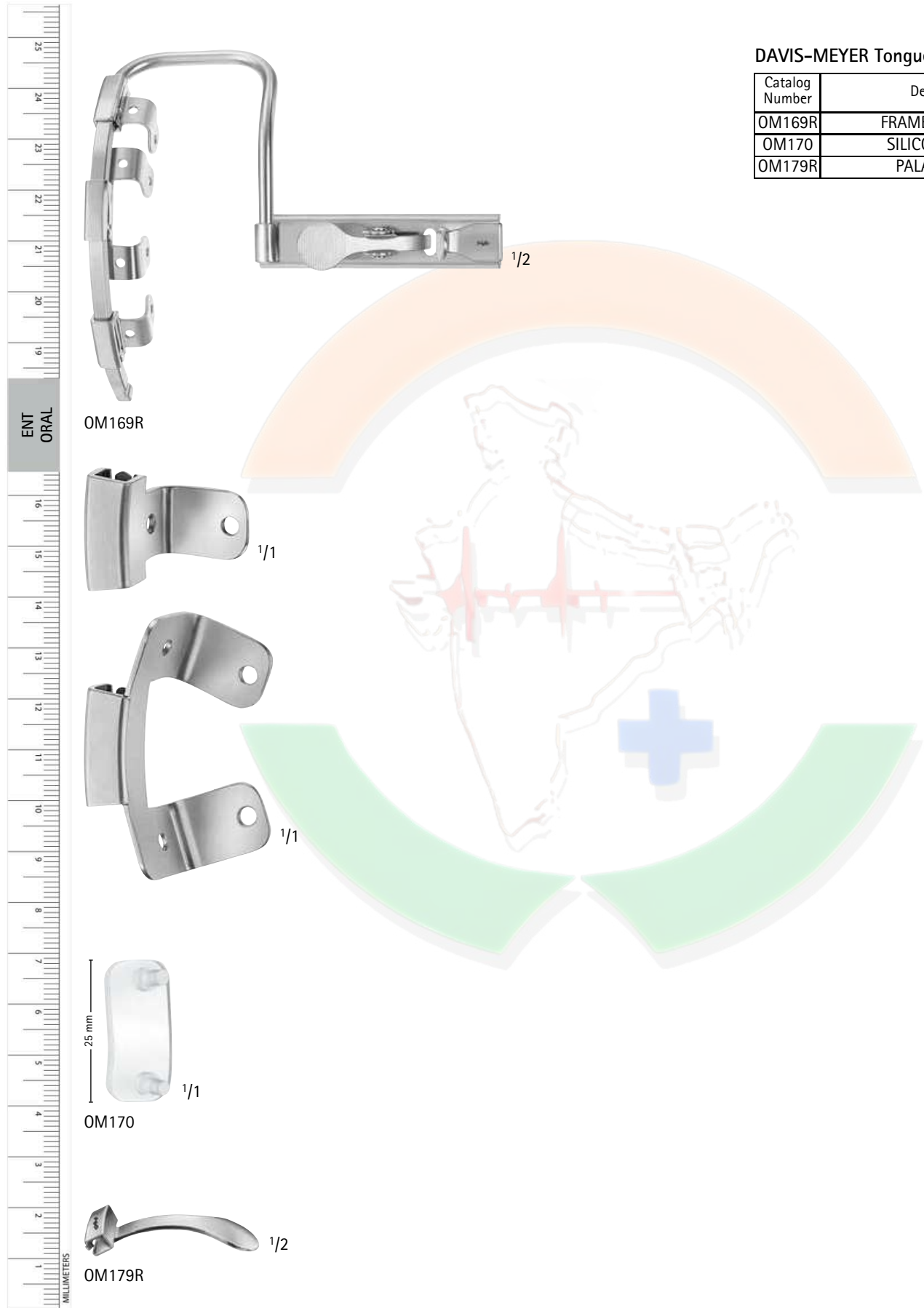



**ENT-ORAL MOUTH GAGS**

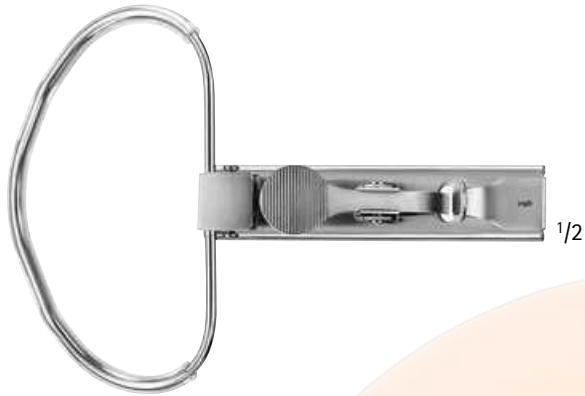

MA311R



MA312R-MA314R

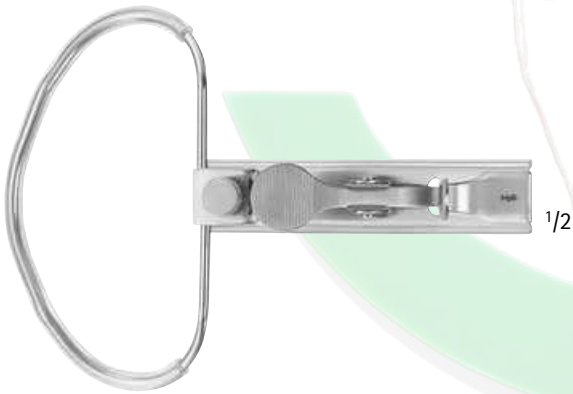

OM104R

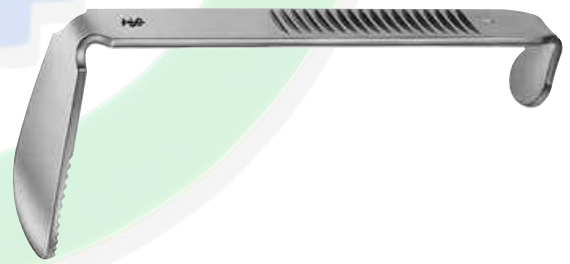

OM101R-OM103R



MB595R-MB600R



MA300R-MA301R

**MCIVOR Mouth Gag**

Catalog Number	Blade Size (mm)	Size (#)	Description	Length (in.)
MA311R	-	-	COMPLETE WITH FRAME AND 3 TONGUE BLADES	-
MA312R	22 x 69	1	BLADE	5 3/8
MA313R	24 x 90	2	BLADE	5 3/8
MA314R	25 x 100	3	BLADE	5 3/8
OM104R	-	-	FRAME F/ TONGUE DEPRESSOR	5 1/2
OM104201	-	-	REPLACEMENT TUBE F/ OM104R	-
OM101R	25 x 55	-	BLADE	-
OM102R	25 x 62	-	BLADE	-
OM103R	25 x 75	-	BLADE	-
MB595R	57 x 23	2	BLADE, RIGHT	-
MB596R	72 x 27	3	BLADE, RIGHT	-
MB597R	88 x 33	4	BLADE, RIGHT	-
MB598R	57 x 23	2	BLADE, LEFT	-
MB599R	72 x 27	3	BLADE, LEFT	-
MB600R	88 x 33	4	BLADE, LEFT	-
MA301R	97 x 36	5	BLADE, LEFT	-
MA300R	97 x 36	5	BLADE, RIGHT	-





**ENT-ORAL MOUTH GAGS**

**RUSSEL-DAVIS Tongue Blade**

Catalog Number	Blade Size (mm)
OM171R	29 x 67
OM172R	33 x 75
OM173R	38 x 85
OM174R	40 x 92
OM175R	46 x 100
OM176R	18 x 57
OM177R	22 x 67
OM178R	25 x 75

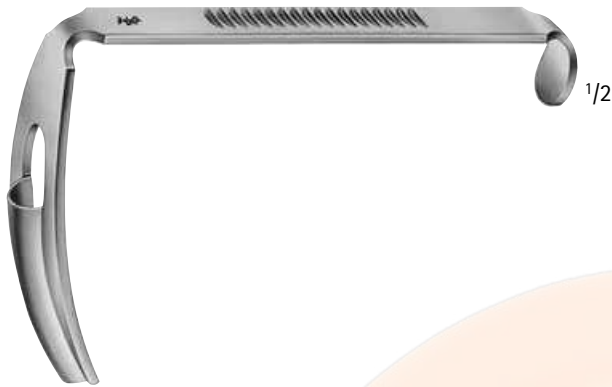

OM171R-OM178R



OM171R



OM172R



OM173R



OM174R

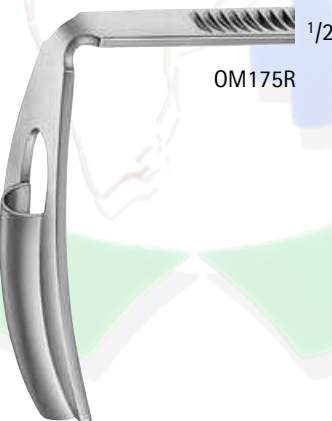

OM175R



OM176R



OM177R



OM178R

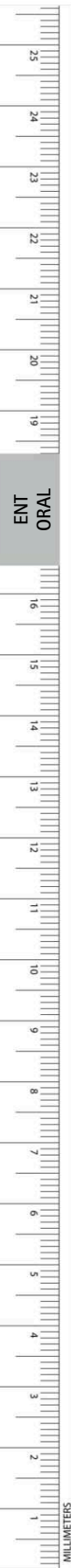





**ENT-ORAL MOUTH GAGS**



OM181R-OM183R

**GAST Tongue Blade**

Catalog Number	Blade Size (mm)
OM181R	28 x 64
OM182R	34 x 74
OM183R	38 x 87

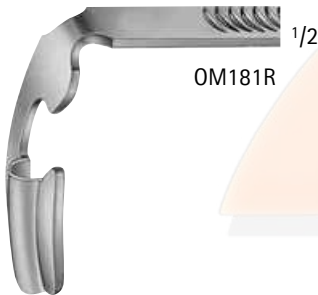

OM181R



OM182R



OM183R

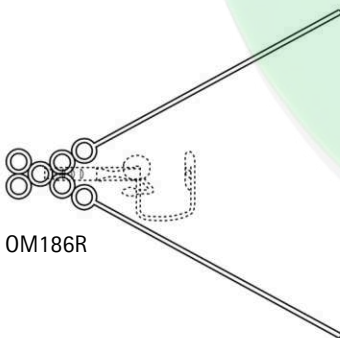

OM186R

**DRAFFIN Chest Support, W/ 4 Height Rings**

Catalog Number	Length (in.)
OM186R	18 7/8

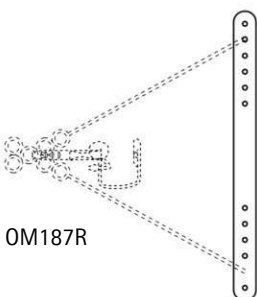

OM187R

**MAGAURAN Plate, F/ Holding OM186R**

Catalog Number	Length (in.)
OM187R	16





**ENT-ORA TONSIL KNIVES**

L



OM681R



OM681R

**ABRAHAM Tonsil Knife**

Catalog Number	Length (in.)
OM681R	8 3/4

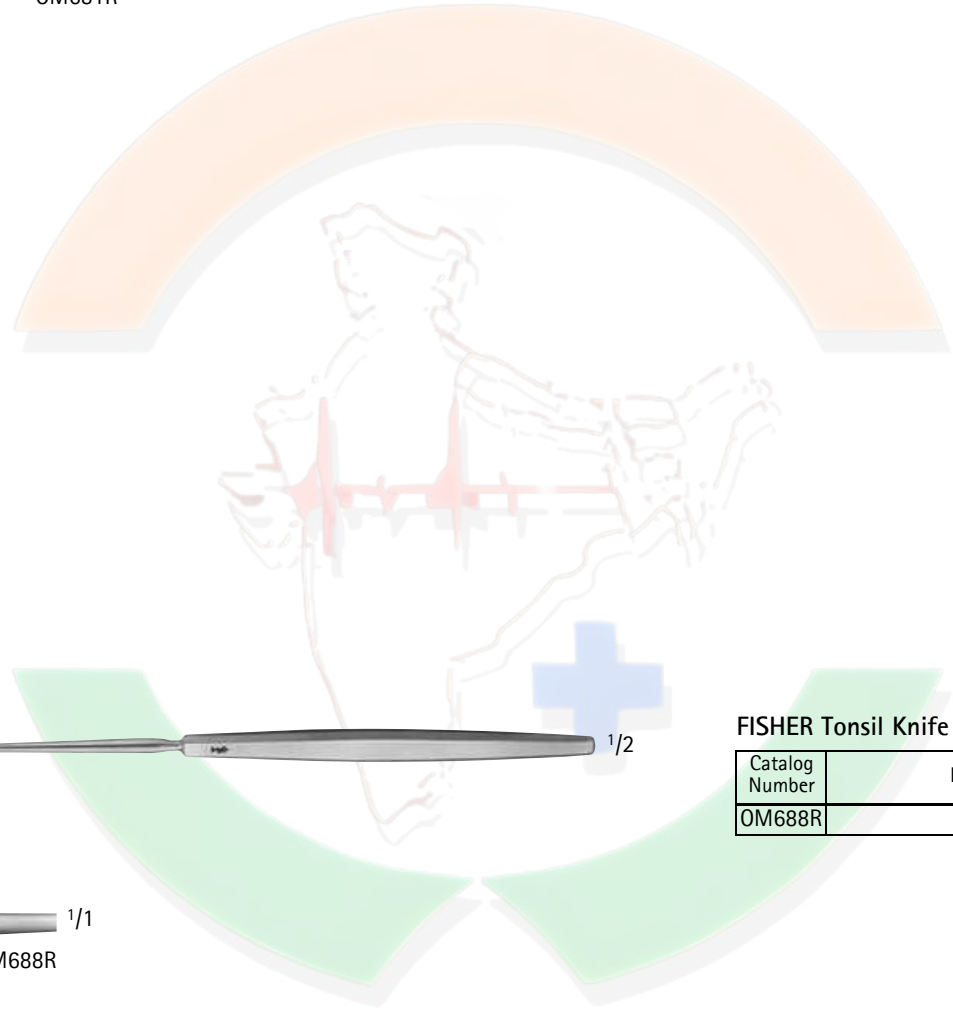

OM688R



OM688R

**FISHER Tonsil Knife**

Catalog Number	Length (in.)
OM688R	8



**ENT-ORAL SUCTION TUBES**



**ANDREWS Pynchon Suction Tube**

Catalog Number	Description	Length (in.)
MD613	-	9
MD613001	TIP ONLY F/ MD613	-

MD613



MD613001

OP360R-OP362R

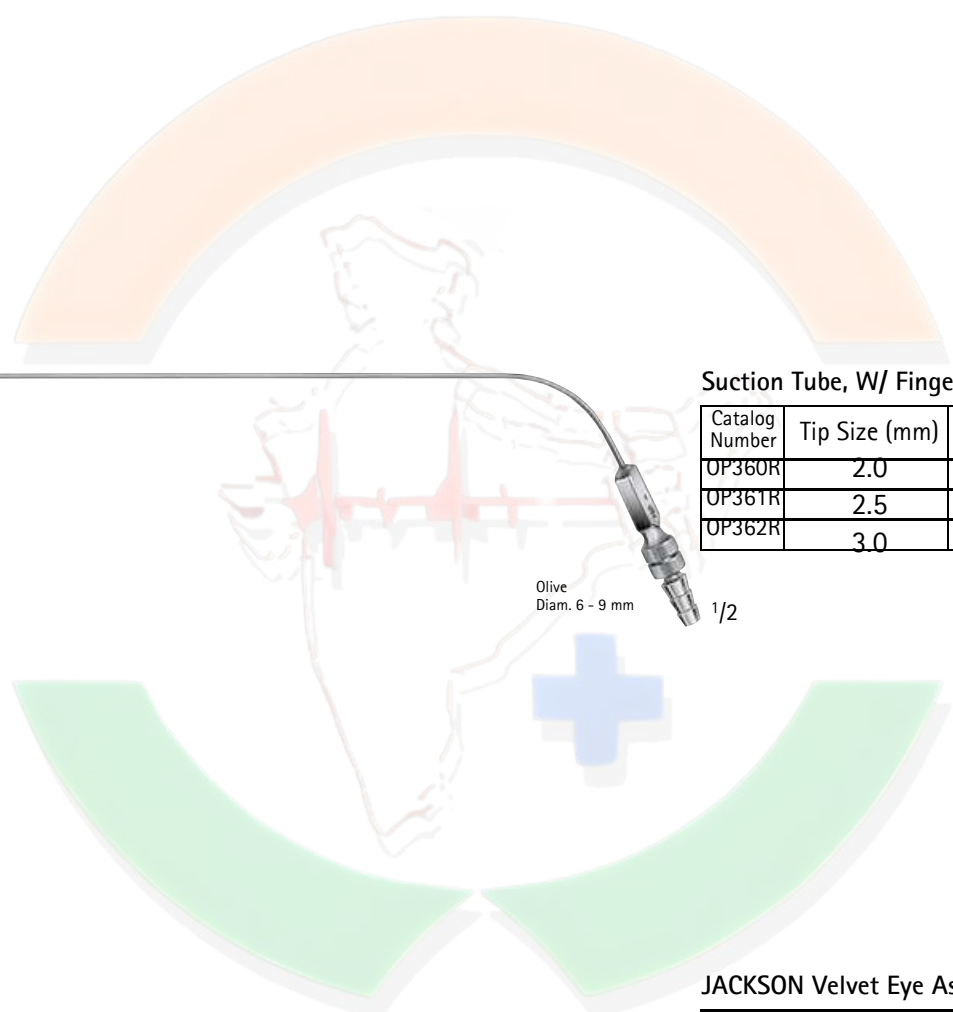

**Suction Tube, W/ Finger Cut-0**

Catalog Number	Tip Size (mm)	Working Length (in.)
OP360R	2.0	9 3/4
OP361R	2.5	9 3/4
OP362R	3.0	9 3/4

Olive  
Diam. 6 - 9 mm

MB366R-MB369R



**JACKSON Velvet Eye Aspirating Tube**

Catalog Number	Diameter (mm)	Length (in.)
MB366R	4.0	10
MB367R	4.0	16 3/8
MB368R	4.0	22
MB369R	4.0	18 1/8



**ENT-ORAL CURETTES**



OM471R-OM474R

**BARNHILL Adenoid Curette**

Catalog Number	Tip Size (mm)	Length (in.)
OM471R	11	7 7/8
OM472R	13	7 7/8
OM473R	15	7 7/8
OM474R	17	7 7/8

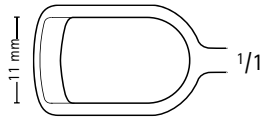

OM471R



OM472R



OM473R

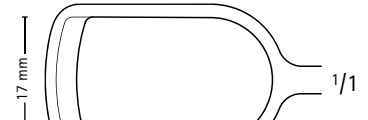

OM474R



OM451R-OM456R

**BECKMANN Adenoid Curette**

Catalog Number	Tip Size (mm)	Length (in.)
OM451R	9.25	7 7/8
OM452R	11.5	7 7/8
OM453R	12	7 7/8
OM454R	13	7 7/8
OM455R	15.5	7 7/8
OM456R	16	7 7/8
OM500R	10	8 3/4
OM501R	12	8 3/4
OM502R	14	8 3/4
OM503R	16	8 3/4
OM504R	18	8 3/4
OM505R	20	8 3/4



OM451R



OM452R

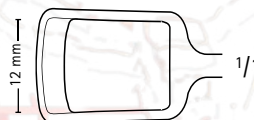

OM453R

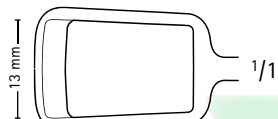

OM454R

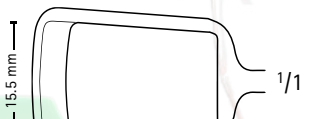

OM455R



OM456R



OM500R-OM505R



OM500R



OM501R



OM502R

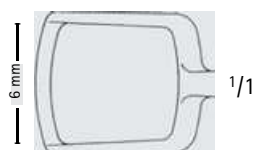

OM503R



OM504R



OM505R



**ENT-ORAL CURETTES**



**JONES Adenoid Curette**

Catalog Number	Tip Size (mm)	Size (#)	Size	Length (in.)
MA656R	4	1	INFANT	8 3/4
MA655R	6	2	CHILD	8 7/8
MA654R	8	3	ADULT	8 7/8



MA656R



MA655R



MA654R



**MIDDLETON Adenoid Curette**

Catalog Number	Tip Size (mm)	Length (in.)
MA291R	7	8 7/8

MA291R



MA291R



**NEGUS Adenoid Curette**

Catalog Number	Tip Size (mm)	Length (in.)
OM510R	10	7 7/8
OM511R	12.25	7 7/8
OM512R	14	7 7/8
OM513R	16.5	7 7/8
OM514R	18	7 7/8

OM510R-OM514R

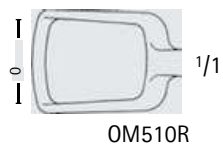

OM510R

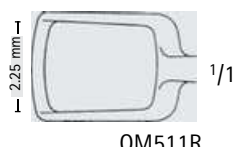

OM511R

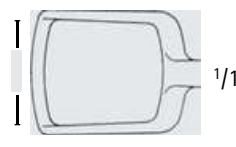

OM512R



OM513R



OM514R





**ENT-ORAL CURETTES**

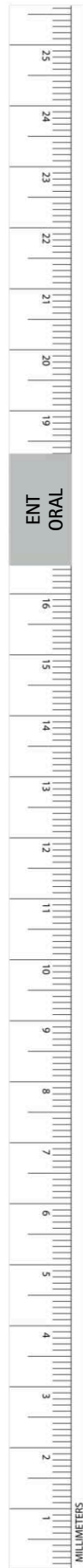

US149-US150



US149



US150



MA066R-MA067R

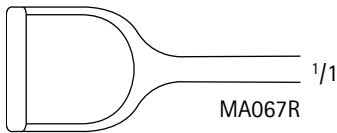

MA067R



MA066R



MB316R



MB316R

**STUBBS Adenoid Curette**

Catalog Number	Tip Size (mm)	Size (#)	Length (in.)
US149	11	0	8 1/2
US150	14	1	8 1/2
MA067R	16	2	8 1/2
MA066R	18	3	8 1/2

**VOGEL Adenoid Curette, Infant**

Catalog Number	Tip Size (mm)	Length (in.)
MB316R	7	8 1/2

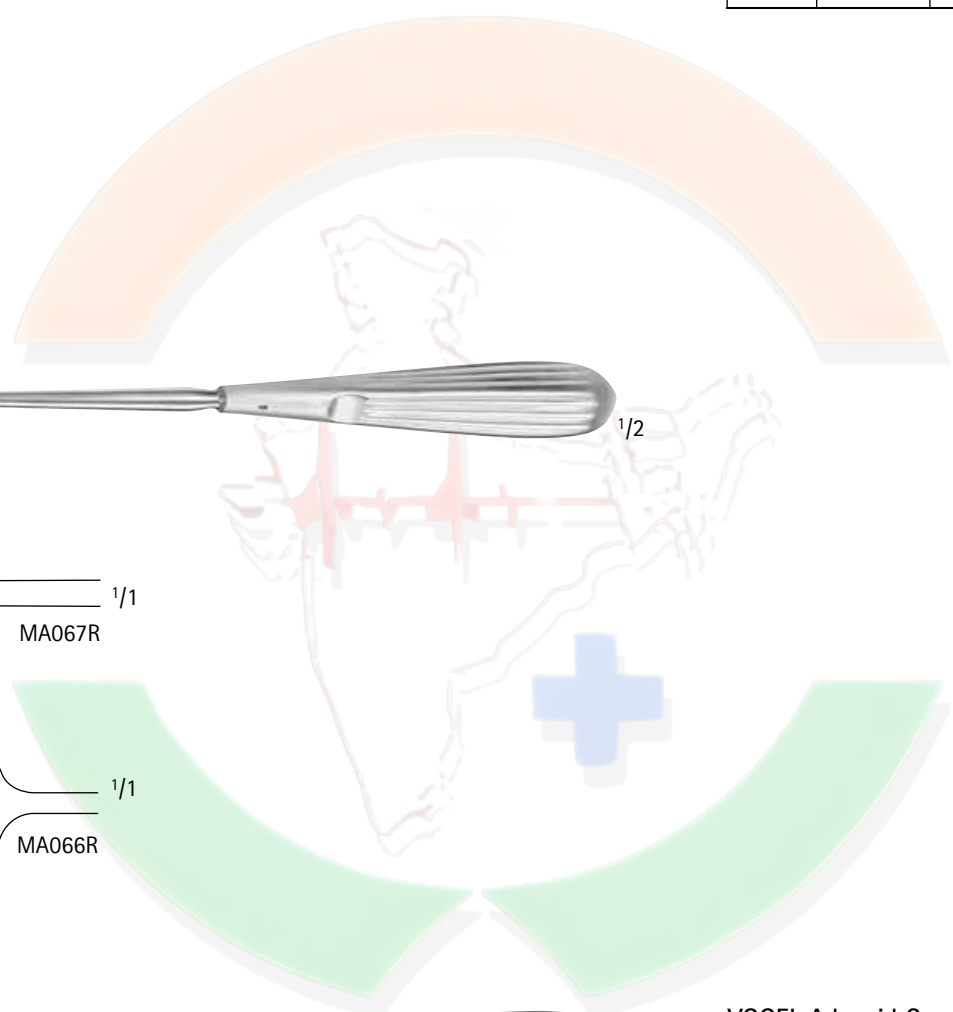



**AMRAMED**<sup>TM</sup>  
TECH Pvt. Ltd.<sup>R</sup>

**Wholesale Supplier**

A to Z Hospital Equipment and  
Surgical Products B to C



**Certified Register**

**ENT-ORAL SYRINGES**

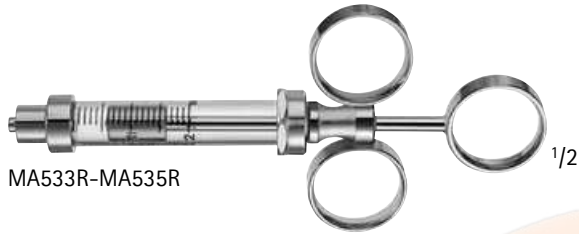

MA533R-MA535R

**Syringe**

Catalog Number	Diameter (mm)	Volume (cc)	Length (in.)
MA533R	11	3	5 1/2
MA534R	14	5	5 1/2
MA535R	17	10	5 1/2





**ENT-ORAL LARYNGEAL MIRRORS**



OM078R-OM090R

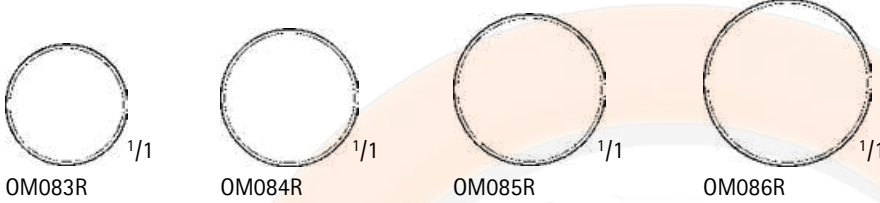
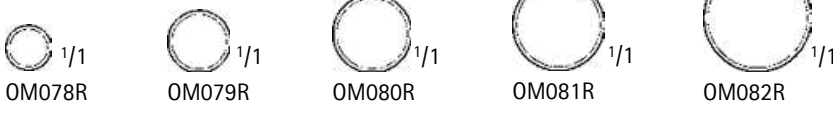

Laryngeal Mirror, Rigid, W/ Hex Handle

Catalog Number	Size (#)	Diameter (mm)	Length (in.)
OM078R	000	6.0	7
OM079R	00	8.0	7
OM080R	0	10.0	7
OM081R	1	12.0	7
OM082R	2	14.0	7
OM083R	3	16.0	7
OM084R	4	18.0	7
OM085R	5	20.0	7
OM086R	6	22.0	7
OM087R	7	24.0	7
OM088R	8	26.0	7
OM089R	9	28.0	7
OM090R	10	30.0	7



AC468R-AC480R



AC481R

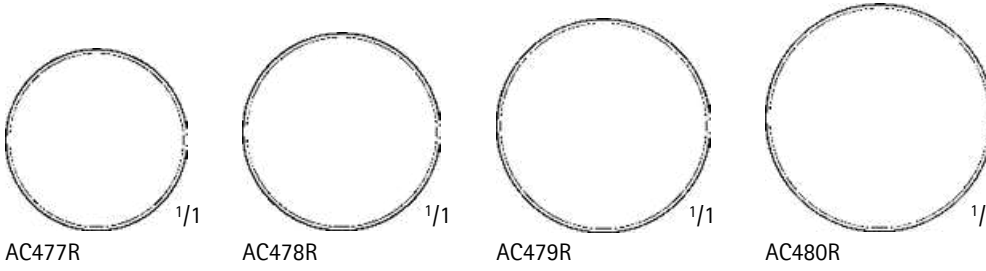
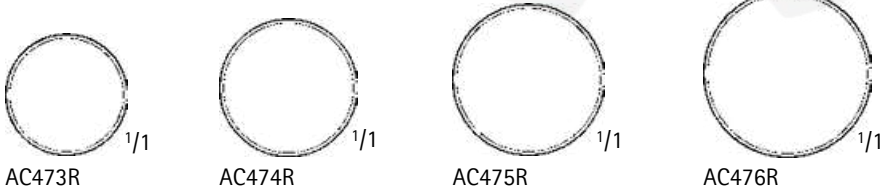

Laryngeal Mirror, Rigid, F/ Handle  
AC481R

Catalog Number	Size (#)	Diameter (mm)	Length (in.)
AC468R	000	6.0	4 3/4
AC469R	00	8.0	4 3/4
AC470R	0	10.0	4 3/4
AC471R	1	12.0	4 3/4
AC472R	2	15.0	4 3/4
AC473R	3	16.0	4 3/4
AC474R	4	18.0	4 3/4
AC475R	5	20.0	4 3/4
AC476R	6	22.0	4 3/4
AC477R	7	24.0	4 3/4
AC478R	8	26.0	4 3/4
AC479R	9	28.0	4 3/4
AC480R	10	30.0	4 3/4
AC481R	-	HANDLE	4 1/4





**ENT-ORAL AMALGAM CARRIERS**



MG574R

**Amalgam Carrier, Double Ended**

Catalog Number	Size	Length (in.)
MG574R	MEDIUM / LARGE	7 7/8



MG574R

