



Wholesale Supplier General_Surgery_Instrument A to Z Hospital Equipment and Surgical Products **B to C**



General Surgery

| | |
|--|-----------|
| Scissors | 2 - 52 |
| Needle Holders and Cases | 53 - 76 |
| Ligature Needles | 77 - 78 |
| Forceps and Clamps | 79 - 189 |
| Skin Hooks | 190 - 192 |
| Retractors | 193 - 254 |
| Universal Ring Retractor System | 255 - 271 |
| Self Retaining Retractors | 272 - 283 |
| Rectal Specula Instruments | 284 - 291 |
| Probes, Dilators and Scoops | 292 - 299 |
| Scalpel Blades and Handles | 300 - 307 |
| Amputation and Autopsy Instruments | 308 - 310 |
| Suction Instruments | 311 - 322 |
| Rulers, Calipers and Accessories | 323 - 324 |
| Metal Bowls and Cups | 325 |

8275140877

9822688071

info@amramedtech.com



**Sr No.29/1/2, Adarsh Nagar,
Uruli Devachi, Hadapsar, Pune
Branches :- All Maharashtra**



amramedtech.com



GENERAL SURGERY SCISSORS



BC374R-BC474R

DEAVER Suture Scissors

| Catalog Number | Tip | Blade | Length (in.) |
|----------------|-----|-------|--------------|
| BC374R | S/B | STR | 5 3/4 |
| BC474R | S/B | CVD | 5 3/4 |
| BC464R | B/B | CVD | 5 3/4 |

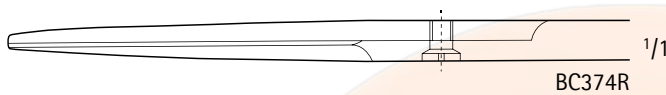

BC374R

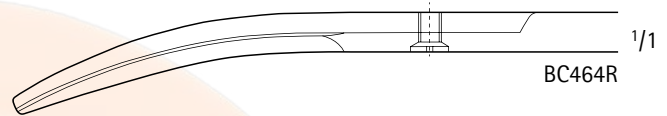

BC464R

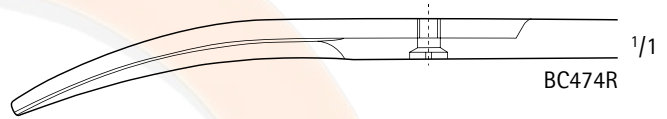

BC474R

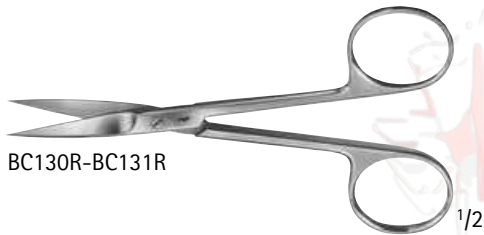

BC130R-BC131R

Suture Scissors

| Catalog Number | Tip | Blade | Length (in.) |
|----------------|-----|-------|--------------|
| BC130R | S/S | STR | 4 3/4 |
| BC341R | S/S | STR | 4 1/2 |
| BC343R | S/S | STR | 5 1/8 |
| BC344R | S/S | STR | 5 3/4 |
| BC345R | S/S | STR | 6 |
| BC346R | S/S | STR | 6 1/2 |
| BC131R | S/S | CVD | 4 3/4 |



BC130R

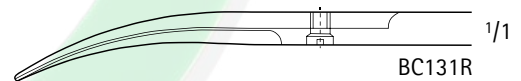

BC131R



BC341R-BC346R

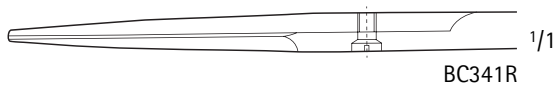

BC341R

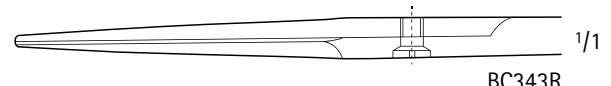

BC343R

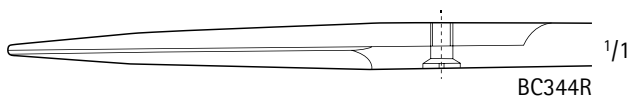

BC344R

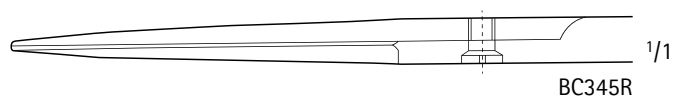

BC345R

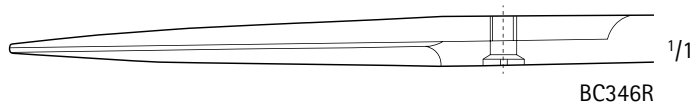

BC346R



GENERAL SURGERY SCISSORS



BC441R-BC445R

Suture Scissors

| Catalog Number | Tip | Blade | Length (in.) |
|----------------|-----|-------|--------------|
| BC441R | S/S | CVD | 4 1/2 |
| BC443R | S/S | CVD | 5 1/8 |
| BC444R | S/S | CVD | 5 3/4 |
| BC445R | S/S | CVD | 6 |



BC441R

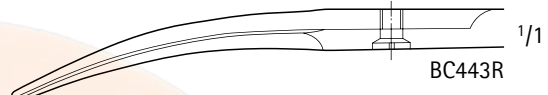

BC443R



BC444R



BC445R



BC303R-BC304R

Suture Scissors

| Catalog Number | Tip | Blade | Length (in.) |
|----------------|-----|----------|--------------|
| BC303R | S/B | DEL, STR | 5 1/8 |
| BC304R | S/B | DEL, STR | 5 3/4 |

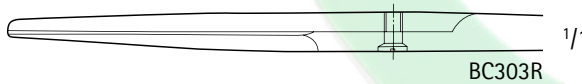

BC303R



BC304R



BC496R

Scissors

| Catalog Number | Tip | Blade | Length (in.) |
|----------------|-----|------------|--------------|
| BC496R | S/B | STR/1-SERR | 5 1/8 |

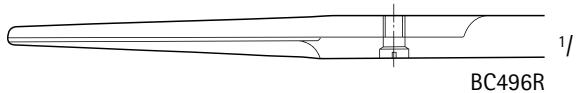

BC496R





GENERAL SURGERY SCISSORS



BC320R-BC330R

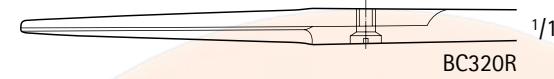

BC320R



BC321R



BC323R



BC324R



BC325R



BC326R



BC327R

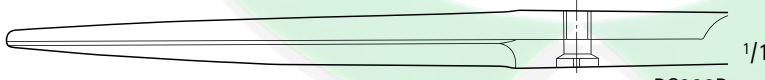

BC328R



BC330R

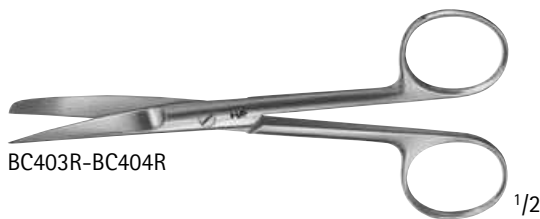

BC403R-BC404R

1/2

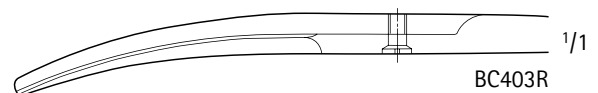

BC403R

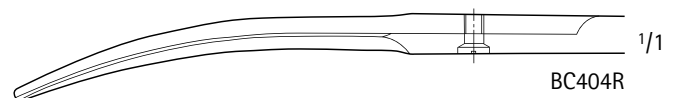

BC404R

Suture Scissors

| Catalog Number | Tip | Blade | Length (in.) |
|----------------|-----|-------|--------------|
| BC320R | S/B | STR | 4 1/8 |
| BC321R | S/B | STR | 4 1/2 |
| BC323R | S/B | STR | 5 1/8 |
| BC324R | S/B | STR | 5 3/4 |
| BC325R | S/B | STR | 6 |
| BC326R | S/B | STR | 6 1/2 |
| BC327R | S/B | STR | 6 7/8 |
| BC328R | S/B | STR | 7 1/4 |
| BC330R | S/B | STR | 7 7/8 |
| BC403R | S/B | CVD | 5 1/8 |
| BC404R | S/B | CVD | 5 3/4 |



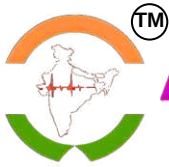

GENERAL SURGERY SCISSORS



BC421R-BC428R

Suture Scissors

| Catalog Number | Tip | Blade | Length (in.) |
|----------------|-----|-------|--------------|
| BC421R | S/B | CVD | 4 1/2 |
| BC423R | S/B | CVD | 5 1/8 |
| BC424R | S/B | CVD | 5 3/4 |
| BC425R | S/B | CVD | 6 |
| BC426R | S/B | CVD | 6 1/2 |
| BC428R | S/B | CVD | 7 1/4 |

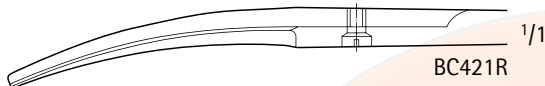

BC421R

1/1



BC423R

1/1



BC424R

1/1



BC425R

1/1



BC426R

1/1



BC428R

1/1



BC135R

1/2

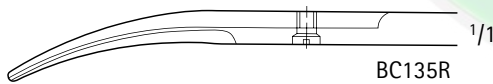

BC135R

1/1

Suture Scissors

| Catalog Number | Tip | Blade | Length (in.) |
|----------------|-----|----------|--------------|
| BC135R | B/B | CVD, DEL | 4 3/4 |





GENERAL SURGERY SCISSORS

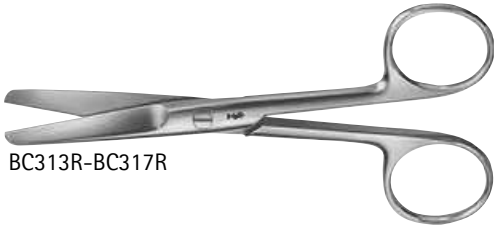

BC313R-BC317R



BC411R-BC417R

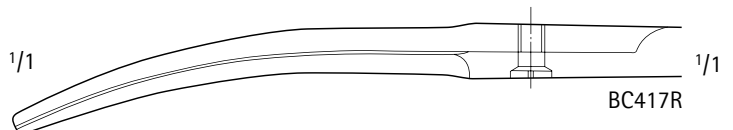
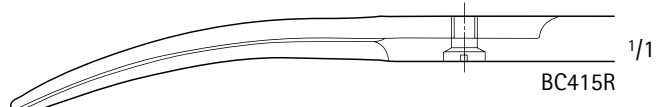
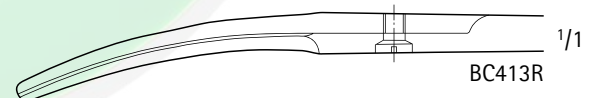
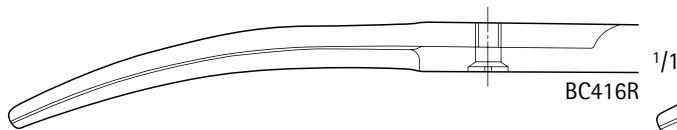
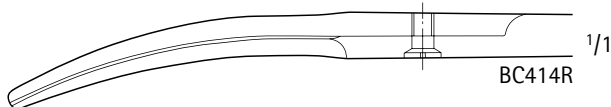

COOPER Suture Scissors

| Catalog Number | Tip | Blade | Length (in.) |
|----------------|-----|-------|--------------|
| BC313R | B/B | STR | 5 1/8 |
| BC314R | B/B | STR | 5 3/4 |
| BC315R | B/B | STR | 6 |
| BC316R | B/B | STR | 6 1/2 |
| BC317R | B/B | STR | 6 7/8 |
| BC411R | B/B | CVD | 4 1/2 |
| BC413R | B/B | CVD | 5 1/8 |
| BC414R | B/B | CVD | 5 3/4 |
| BC415R | B/B | CVD | 6 |
| BC416R | B/B | CVD | 6 1/2 |
| BC417R | B/B | CVD | 6 7/8 |



GENERAL SURGERY SCISSORS

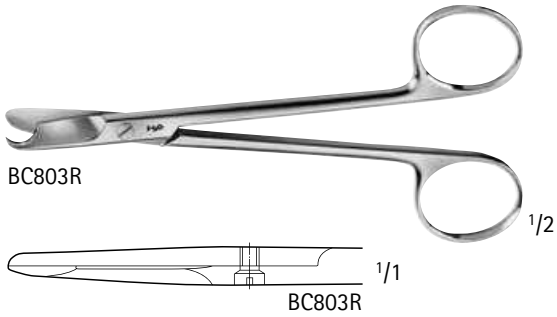

LITTAUER Ligature Scissors

| Catalog Number | Tip | Blade | Length (in.) |
|----------------|-----------|-------|--------------|
| BC803R | B/1-NOTCH | STR | 5 1/4 |

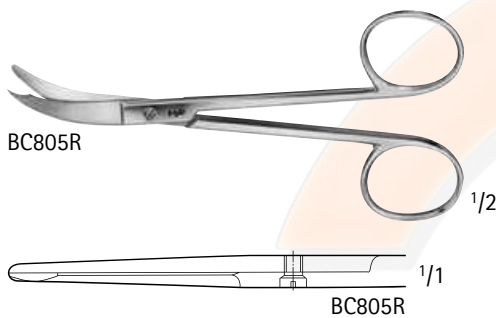

NORTHBENT Ligature Scissors

| Catalog Number | Tip | Blade | Length (in.) |
|----------------|-----------|---------|--------------|
| BC805R | B/1-NOTCH | LAT-CVD | 4 3/4 |

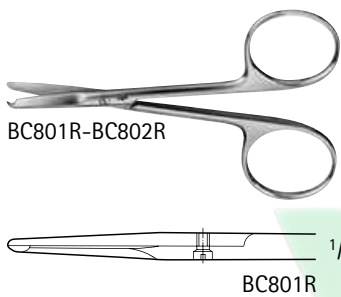

SPENCER Suture Scissors

| Catalog Number | Tip | Blade | Length (in.) |
|----------------|-----------|-------|--------------|
| BC801R | B/1-NOTCH | STR | 3 1/2 |
| BC802R | B/1-NOTCH | STR | 4 1/2 |

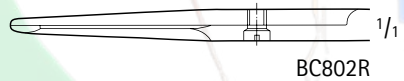

KNOWLES Bandage Scissors

| Catalog Number | Tip | Blade | Length (in.) |
|----------------|---------------|---------|--------------|
| BC846R | 1-PROBE-POINT | STR | 5 3/4 |
| BC847R | 1-PROBE-POINT | LAT-ANG | 5 1/2 |

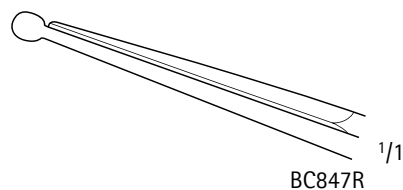
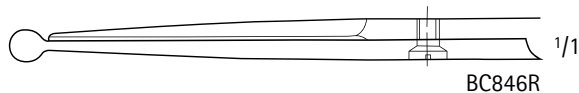



GENERAL SURGERY SCISSORS



BC848R-BC863R

LISTER Bandage Scissors

| Catalog Number | Blade | Length (in.) |
|----------------|----------|--------------|
| BC848R | LONG | 6 1/8 |
| BC849R | LONG | 7 |
| BC860R | STANDARD | 4 1/2 |
| BC861R | STANDARD | 5 1/2 |
| BC862R | STANDARD | 7 |
| BC863R | STANDARD | 7 7/8 |

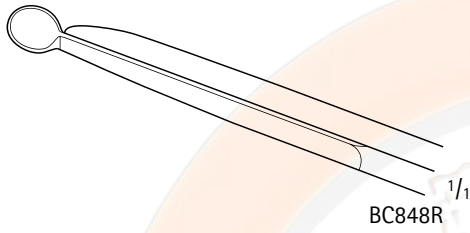

BC848R 1/1

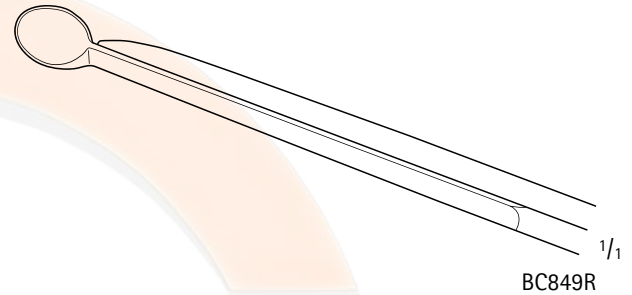

BC849R 1/1

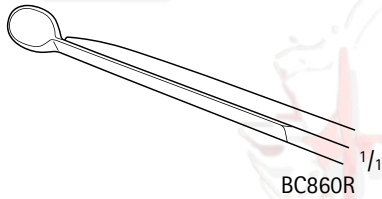

BC860R 1/1

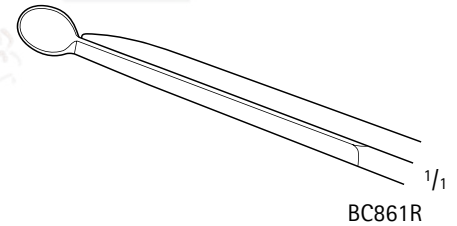

BC861R 1/1

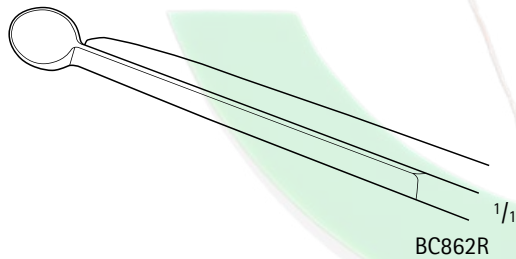

BC862R 1/1

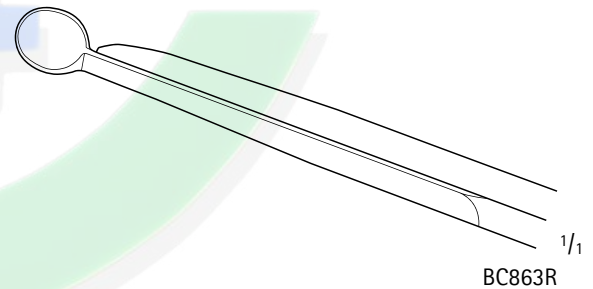

BC863R 1/1



MG379R



MG379R 1/1

LISTER Bandage Scissors, Gold Handle

| Catalog Number | Length (in.) |
|----------------|--------------|
| MG379R | 5 1/2 |





GENERAL SURGERY SCISSORS



LISTER Bandage Scissors, W/ One Large Ring

| Catalog Number | Length (in.) |
|----------------|--------------|
| MB223 | 8 |

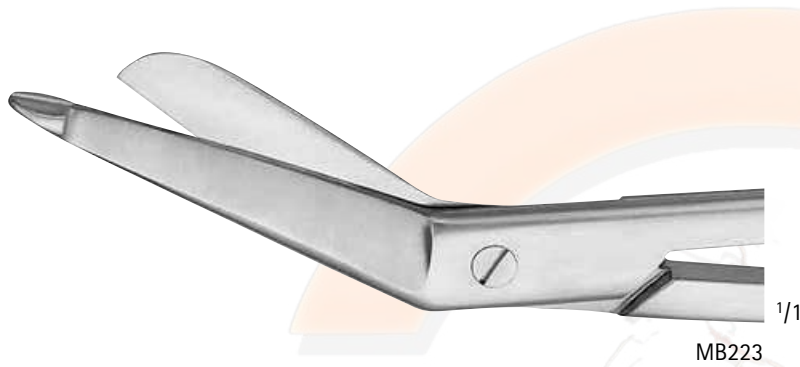

LISTER Bandage Scissors, Serrated

| Catalog Number | Length (in.) |
|----------------|--------------|
| MB146R | 3 1/2 |
| BC876R | 6 1/4 |

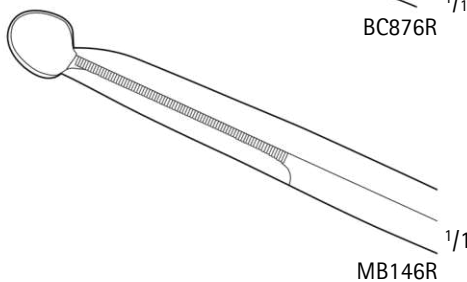
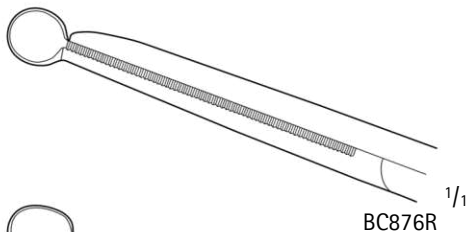



GENERAL SURGERY SCISSORS

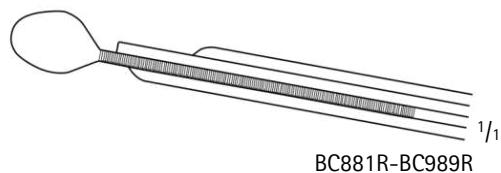
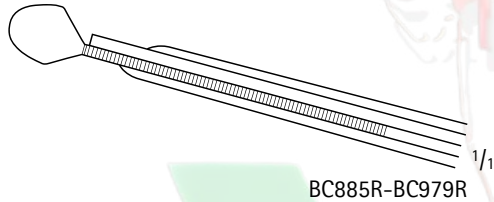
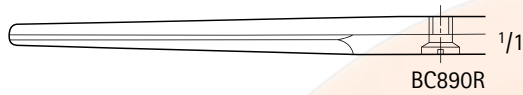

Nurse's Bandage Scissors

| Catalog Number | Tip | Blade | Handle Color | Length (in.) |
|----------------|-----|-------|--------------|--------------|
| BC890R | B/B | STR | RED | 5 3/4 |

LISTER Universal Bandage Scissors, Serrated

| Catalog Number | Handle Color | Length (in.) |
|----------------|--------------|--------------|
| BC885R | BLACK | 5 3/4 |
| BC970R | RED | 5 3/4 |
| BC971R | BLUE | 5 3/4 |
| BC973R | YELLOW | 5 3/4 |
| BC975R | ORANGE | 5 3/4 |
| BC977R | PINK | 5 3/4 |
| BC978R | LIGHT GREEN | 5 3/4 |
| BC979R | VIOLET | 5 3/4 |

Universal Bandage Scissors, W/ One Large Ring, Serrated

| Catalog Number | Handle Color | Length (in.) |
|----------------|--------------|--------------|
| BC881R | BLACK | 7 |
| BC980R | RED | 7 |
| BC981R | BLUE | 7 |
| BC983R | YELLOW | 7 |
| BC985R | ORANGE | 7 |
| BC987R | PINK | 7 |
| BC988R | LIGHT GREEN | 7 |
| BC989R | VIOLET | 7 |



GENERAL SURGERY SCISSORS



STILTE Dissecting Scissors, Round Blades

| Catalog Number | Tip | Blade | Length (in.) |
|----------------|-----|-------|--------------|
| BC580R | B/B | STR | 6 |
| BC581R | B/B | CVD | 6 |

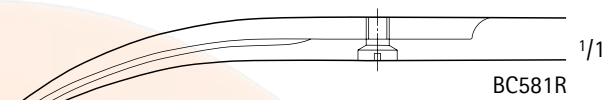
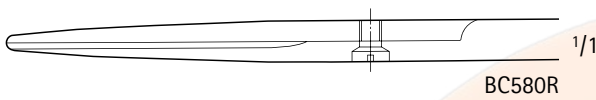

MAYO Dissecting Scissors, Round Blade

| Catalog Number | Tip | Blade | Length (in.) |
|----------------|-----|-------|--------------|
| BC584R | B/B | STR | 6 1/2 |
| BC585R | B/B | STR | 7 7/8 |
| BC587R | B/B | CVD | 6 1/2 |
| BC588R | B/B | CVD | 7 7/8 |
| BC589R | B/B | CVD | 8 1/4 |

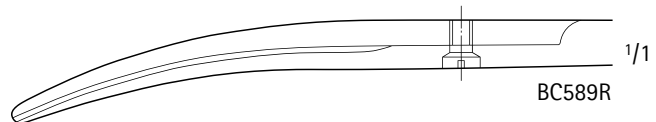
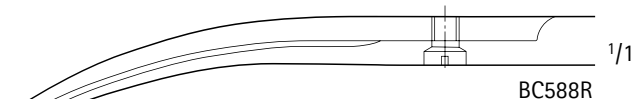
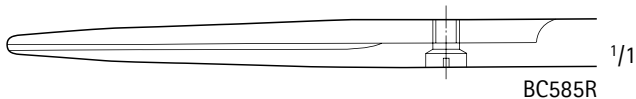
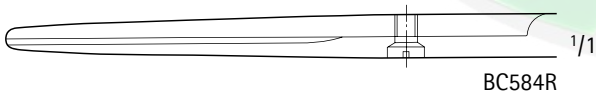

GENERAL SURGERY





GENERAL SURGERY SCISSORS



BC560R-BC561R



BC560R



BC561R

MAYO-HARRINGTON Dissecting Scissors

| | Tip | Blade | Length (in.) |
|--------|-----|-------|--------------|
| BC560R | B/B | STR | 9 |
| BC561R | B/B | CVD | 9 |



BC567R-BC568R

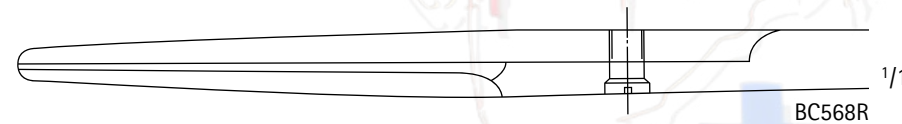

BC568R

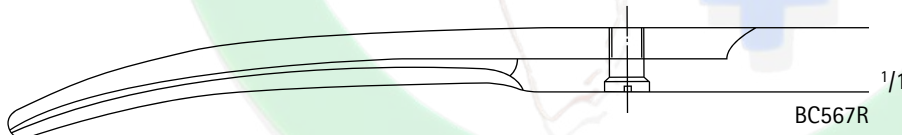

BC567R

MAYO-HARRINGTON Dissecting Scissors

| | Tip | Blade | Length (in.) |
|--------|-----|-------|--------------|
| BC568R | B/B | STR | 1 |
| BC567R | B/B | CVD | 1 |

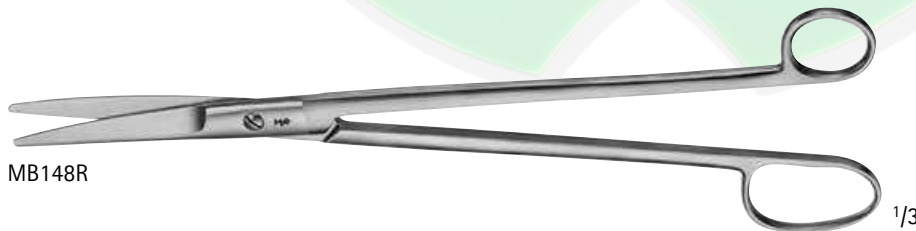

MB148R

MAYO Dissecting Scissors, W/ One Large Ring

| Catalog Number | Tip | Blade | Length (in.) |
|----------------|-----|-------|--------------|
| MB148R | B/B | HEAVY | 14 |



MB148R



AMRAMED
TECH Pvt. Ltd.

Wholesale Supplier

Certified Register

A to Z Hospital Equipment and
Surgical Products B to C



GENERAL SURGERY SCISSORS



BC544R-BC557R

MAYO Dissecting Scissors, Beveled Blade

| Catalog Number | Tip | Blade | Length (in.) |
|----------------|-----|-------|--------------|
| BC544R | B/B | STR | 5 1/2 |
| BC545R | B/B | STR | 6 1/8 |
| BC547R | B/B | STR | 6 3/4 |
| BC562R | B/B | STR | 7 1/2 |
| BC564R | B/B | STR | 8 1/2 |
| BC554R | B/B | CVD | 5 1/2 |
| BC555R | B/B | CVD | 6 1/8 |
| BC557R | B/B | CVD | 6 3/4 |
| BC563R | B/B | CVD | 7 1/2 |
| BC565R | B/B | CVD | 8 1/2 |



BC544R

1/1



BC545R

1/1



BC547R

1/1



BC554R

1/1



BC555R

1/1



BC557R

1/1



BC562R-BC565R

1/2



BC562R

1/1



BC564R

1/1



BC563R

1/1



BC565R

1/1

GENERAL SURGERY





GENERAL SURGERY SCISSORS

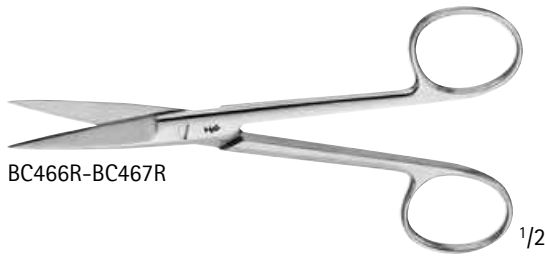
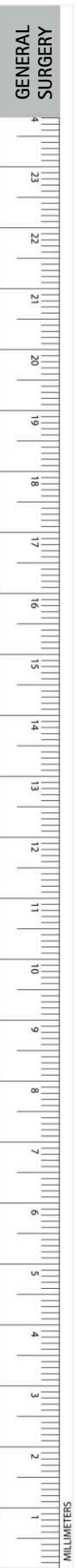

BC466R-BC467R



BC466R

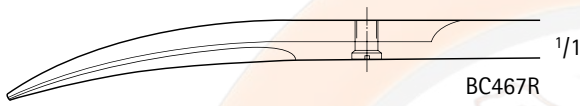

BC467R



BC594R

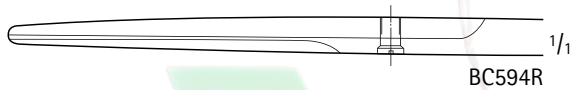

BC594R



BC804R

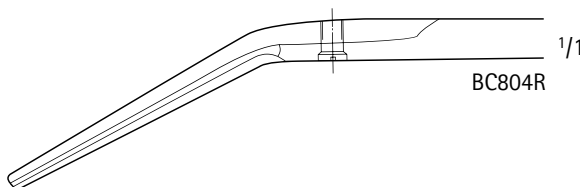

BC804R

MAYO Operating Scissors

| Catalog Number | Tip | Blade | Length (in.) |
|----------------|-----|-------|--------------|
| BC466R | S/S | STR | 5 1/2 |
| BC467R | S/S | CVD | 5 1/2 |

MAYO Dissecting Scissors, Delicate

| Catalog Number | Tip | Blade | Length (in.) |
|----------------|-----|-------|--------------|
| BC594R | B/B | STR | 5 1/2 |

NEW'S Suture Scissors

| Catalog Number | Tip | Blade | Length (in.) |
|----------------|-----|-------|--------------|
| BC804R | B/B | ANG | 5 1/2 |

GENERAL SURGERY SCISSORS

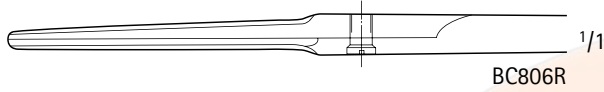

Suture Scissors

| Catalog Number | Tip | Blade | Length (in.) |
|----------------|-----|-------|--------------|
| BC806R | B/B | STR | 4 1/2 |

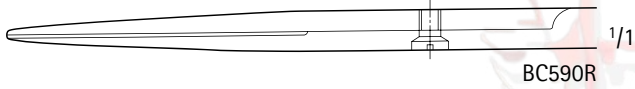

LEXER Dissecting Scissors, Delicate

| Catalog Number | Tip | Blade | Length (in.) |
|----------------|-----|-------|--------------|
| BC590R | B/B | STR | 6 1/2 |
| BC591R | B/B | CVD | 6 1/2 |

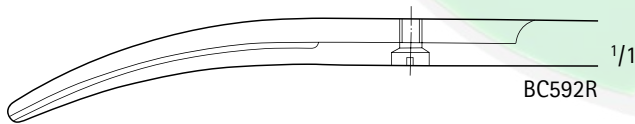
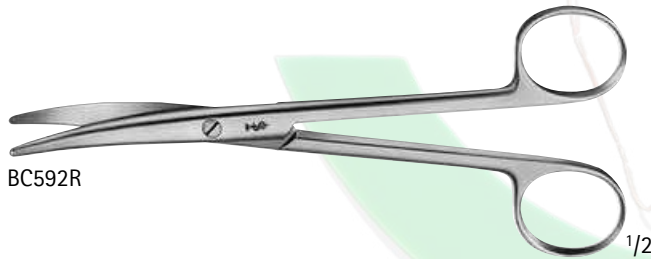
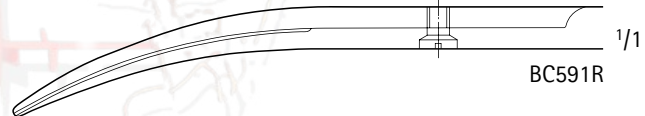

MAYO-LEXER Dissecting Scissors

| Catalog Number | Tip | Blade | Length (in.) |
|----------------|-----|-------|--------------|
| BC592R | B/B | CVD | 6 1/2 |

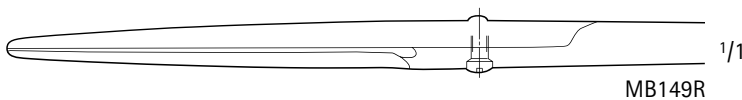

MAYO-SIMS Dissecting Scissors

| Catalog Number | Tip | Blade | Length (in.) |
|----------------|-----|-------|--------------|
| MB149R | B/B | STR | 7 3/4 |





GENERAL SURGERY SCISSORS



BC566R-BC569R

**MAYO-NOBLE Dissecting Scissors,
Broad Blade**

| Catalog Number | Tip | Blade | Length (in.) |
|----------------|-----|-------|--------------|
| BC566R | B/B | STR | 6 3/4 |
| BC569R | B/B | CVD | 6 3/4 |

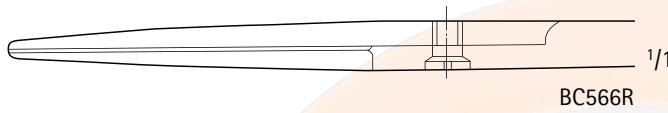

BC566R

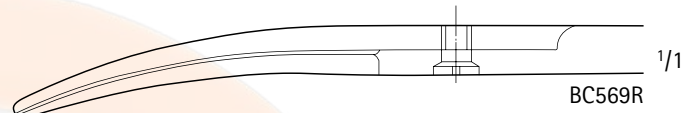

BC569R



BC576R-BC579R

**MAYO-STILLE Dissecting Scissors,
Beveled Blade**

| Catalog Number | Tip | Blade | Length (in.) |
|----------------|-----|-------|--------------|
| BC576R | B/B | STR | 5 1/2 |
| BC578R | B/B | STR | 6 1/2 |
| BC577R | B/B | CVD | 5 1/2 |
| BC579R | B/B | CVD | 6 1/2 |



BC576R



BC577R

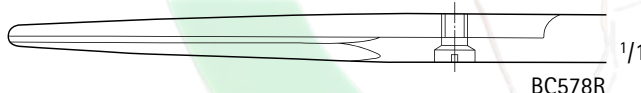

BC578R

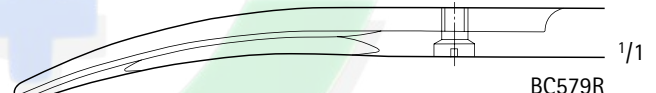

BC579R



BC570R-BC575R

**MAYO-STILLE Dissecting Scissors,
Flat Blade**

| Catalog Number | Tip | Blade | Length (in.) |
|----------------|-----|-------|--------------|
| BC570R | B/B | STR | 5 1/2 |
| BC572R | B/B | STR | 6 3/4 |
| BC573R | B/B | CVD | 5 1/2 |
| BC575R | B/B | CVD | 6 3/4 |

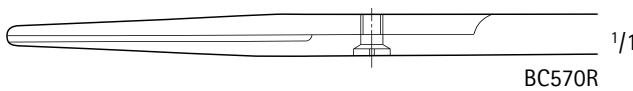

BC570R

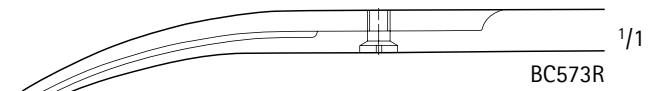

BC573R

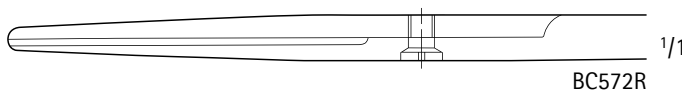

BC572R

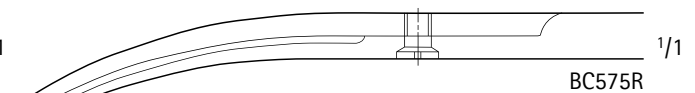

BC575R



GENERAL SURGERY SCISSORS

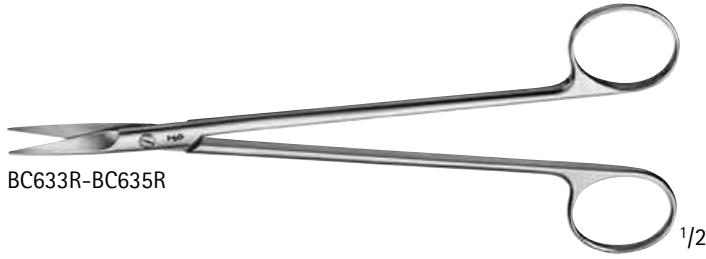

BC633R-BC635R

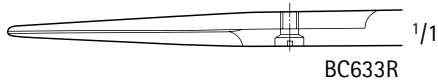

BC633R

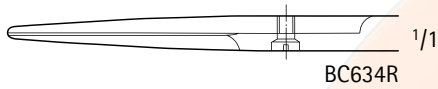

BC634R



BC635R

TOENNIS Dissecting Scissors

| Catalog Number | Tip | Blade | Length (in.) |
|----------------|-----|------------|--------------|
| BC633R | B/B | X-DEL, STR | 7 |
| BC634R | B/B | DEL, STR | 7 |
| BC635R | B/B | DEL, CVD | 7 |



BC628R

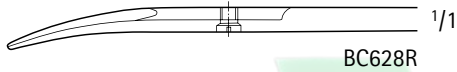

BC628R

Nerve Dissecting Scissors

| Catalog Number | Tip | Blade | Length (in.) |
|----------------|-----|-------|--------------|
| BC628R | S/S | CVD | 6 |



BC630R-BC631R

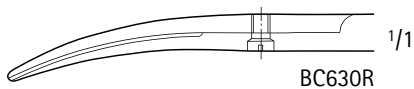

BC630R

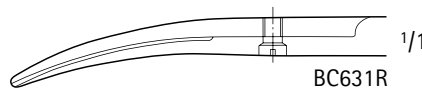

BC631R

TOENNIS-ADSON Dissecting Scissors

| Catalog Number | Tip | Blade | Length (in.) |
|----------------|-------|-------|--------------|
| BC630R | X-DEL | CVD | 6 7/8 |
| BC631R | DEL | CVD | 6 7/8 |





GENERAL SURGERY SCISSORS

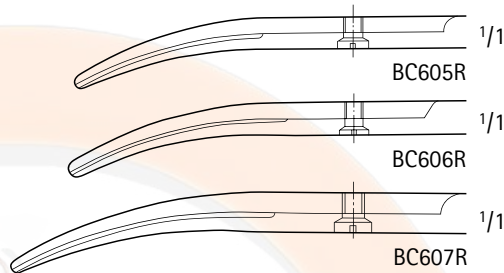
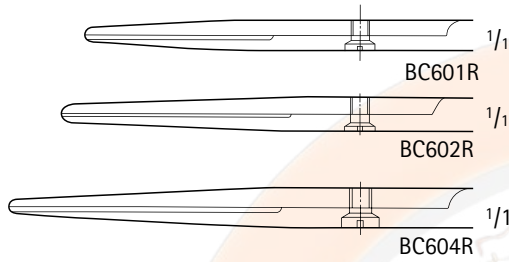

METZENBAUM Dissecting Scissors

| Catalog Number | Tip | Blade | Length (in.) |
|----------------|-----|-------|--------------|
| BC601R | B/B | STR | 5 3/4 |
| BC602R | B/B | STR | 7 |
| BC604R | B/B | STR | 7 7/8 |
| BC605R | B/B | CVD | 5 3/4 |
| BC606R | B/B | CVD | 7 |
| BC607R | B/B | CVD | 7 7/8 |

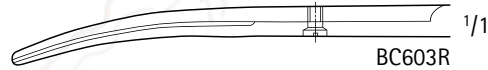

Baby METZENBAUM Dissecting Scissors, Delicate

| Catalog Number | Tip | Blade | Length (in.) |
|----------------|-----|-------|--------------|
| BC600R | B/B | STR | 5 3/4 |
| BC603R | B/B | CVD | 5 3/4 |

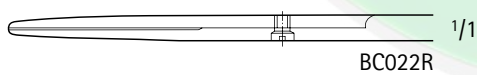
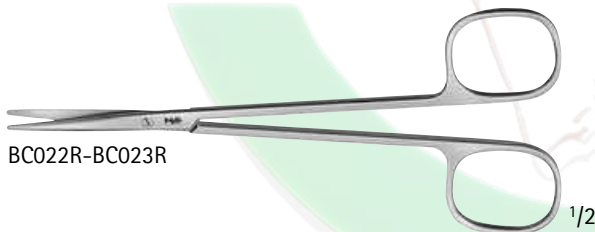

Baby METZENBAUM Dissecting Scissors

| Catalog Number | Tip | Blade | Length (in.) |
|----------------|-----|-------|--------------|
| BC022R | B/B | STR | 5 3/4 |
| BC023R | B/B | CVD | 5 3/4 |

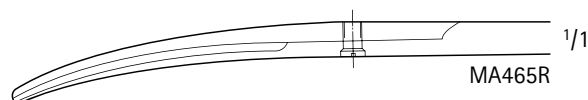

METZENBAUM Scissors, Delicate

| Catalog Number | Tip | Blade | Length (in.) |
|----------------|-----|-------|--------------|
| MA464R | B/B | CVD | 5 1/2 |
| MA465R | B/B | CVD | 8 |



GENERAL SURGERY SCISSORS

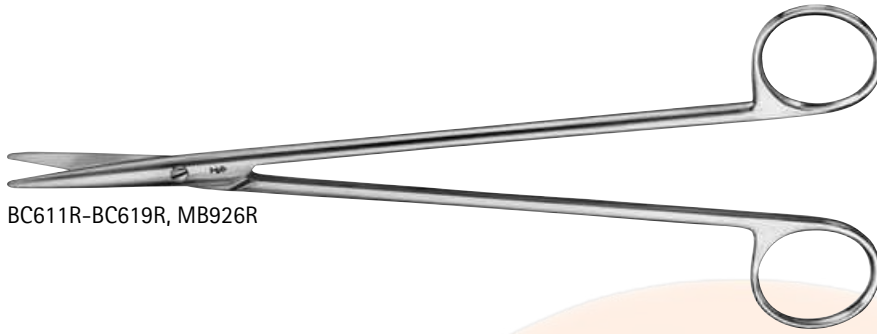

BC611R-BC619R, MB926R

NELSON-METZENBAUM Dissecting Scissors

| Catalog Number | Tip | Blade | Length (in.) |
|----------------|-----|-------|--------------|
| BC611R | B/B | STR | 9 |
| BC612R | B/B | STR | 9 3/4 |
| BC613R | B/B | STR | 11 1/4 |
| BC614R | B/B | STR | 12 |
| BC615R | B/B | CVD | 9 |
| BC616R | B/B | CVD | 9 3/4 |
| BC618R | B/B | CVD | 11 1/4 |
| BC619R | B/B | CVD | 12 |
| MB926R | B/B | CVD | 16 |

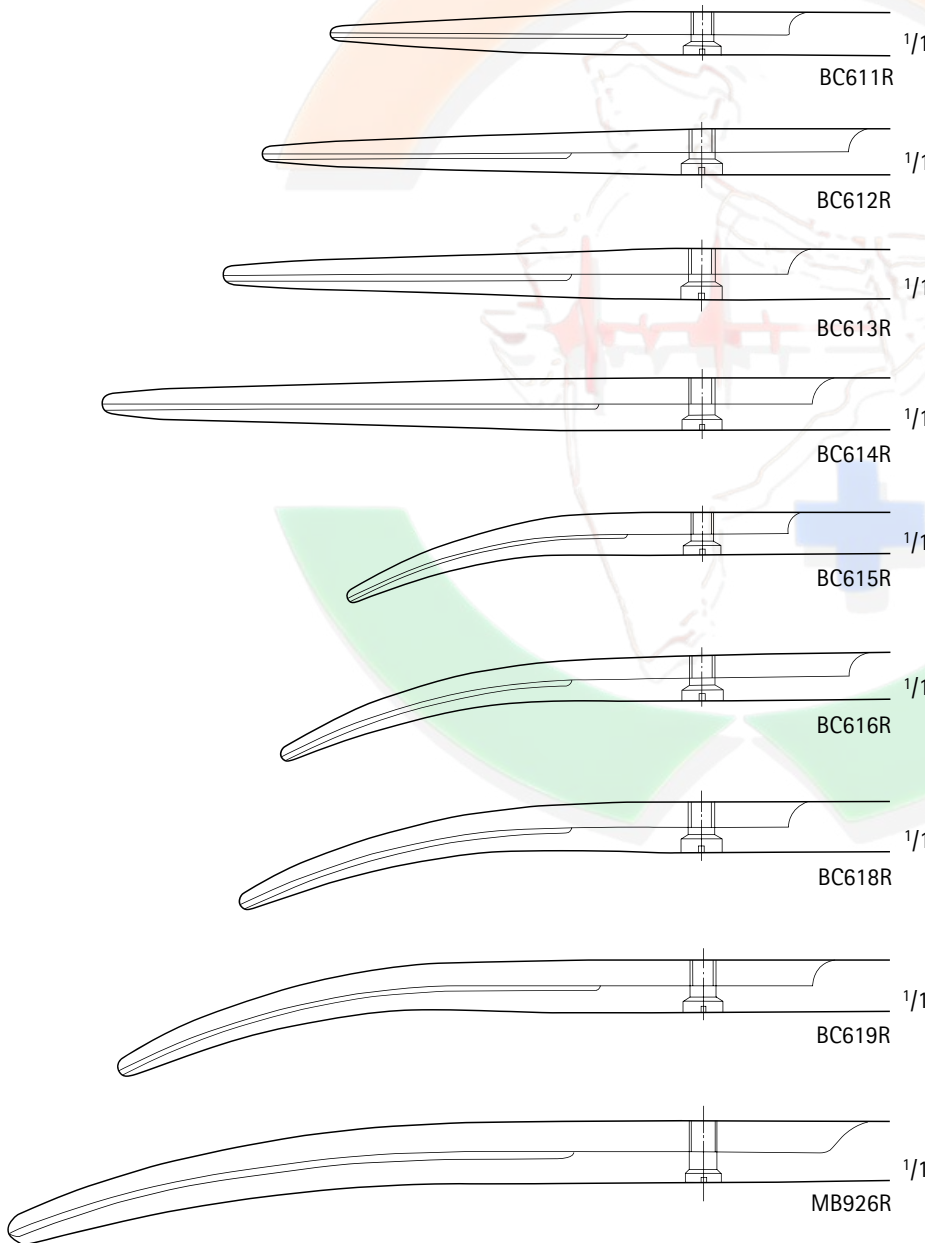



GENERAL SURGERY SCISSORS

GENERAL SURGERY



NELSON-METZENBAUM Dissecting Scissors, Delicate

| Catalog Number | Tip | Blade | Length (in.) |
|----------------|-----|-------|--------------|
| BC625R | B/B | CVD | 13 3/4 |

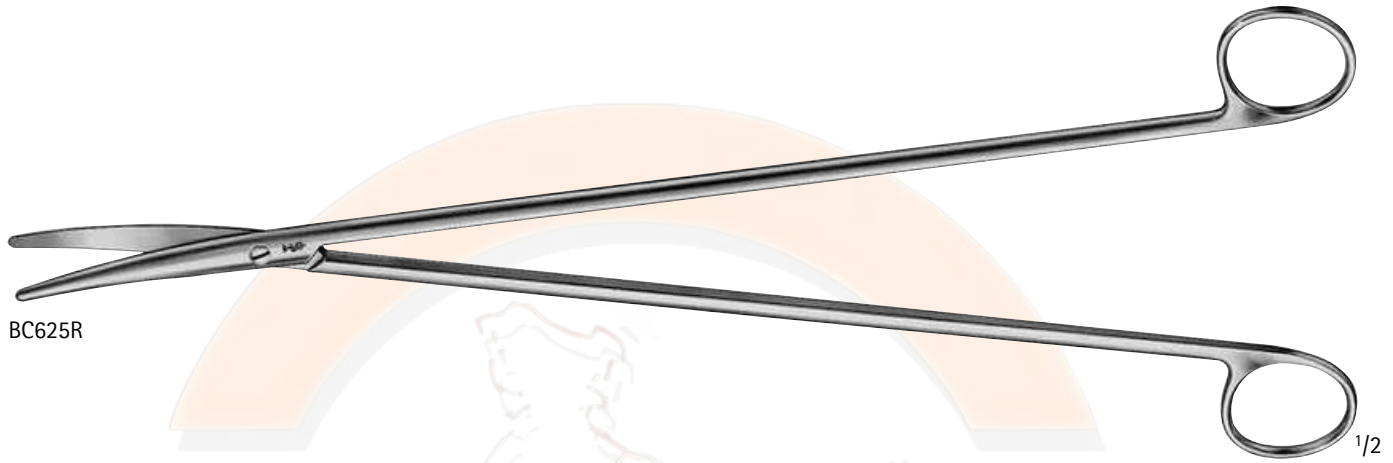

WELLER Dissecting Scissors

| Catalog Number | Tip | Blade | Length (in.) |
|----------------|-----|-----------|--------------|
| BC620R | B/B | HEAVY-CVD | 11 |

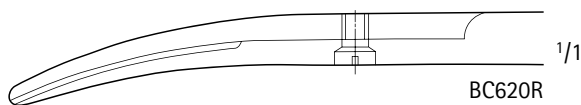
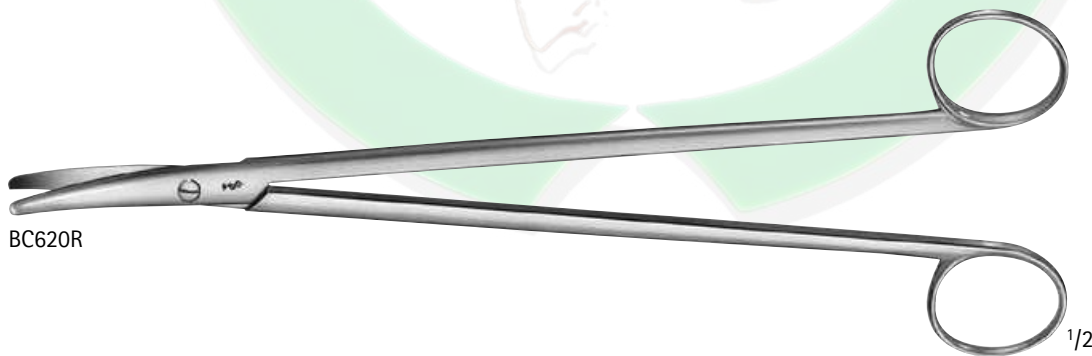



GENERAL SURGERY SCISSORS



BC774R

Abdominal Scissors

| Catalog Number | Tip | Blade | Length (in.) |
|----------------|-----|-------|--------------|
| BC774R | B/B | STR | 7 |

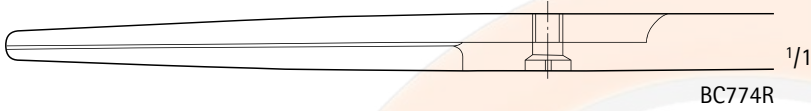

BC774R

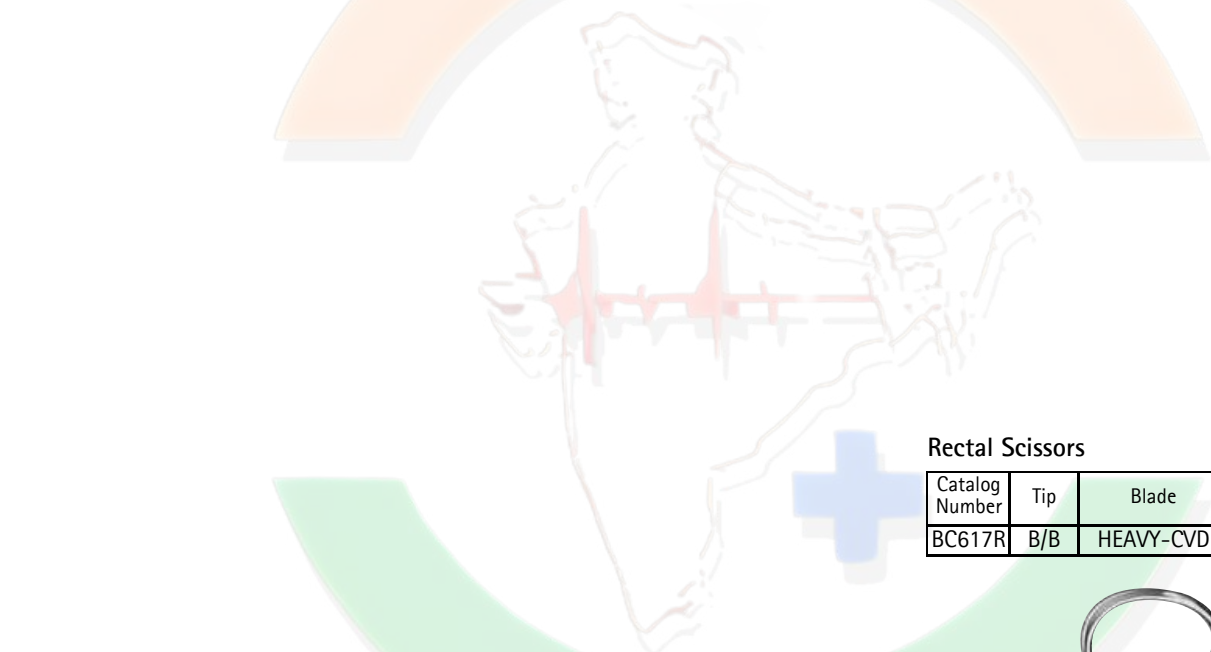

Rectal Scissors

| Catalog Number | Tip | Blade | Length (in.) |
|----------------|-----|-----------|--------------|
| BC617R | B/B | HEAVY-CVD | 12 3/4 |

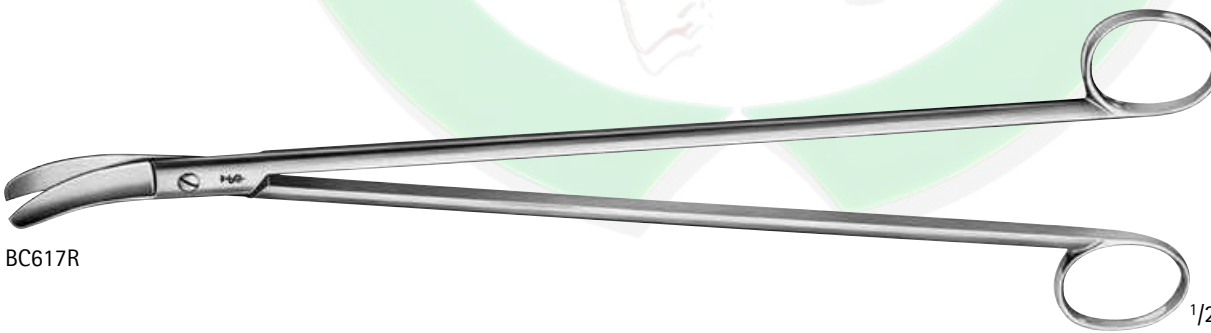

BC617R

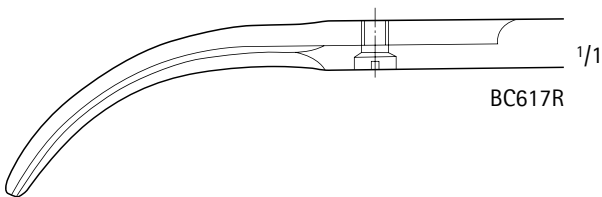

BC617R





GENERAL SURGERY SCISSORS

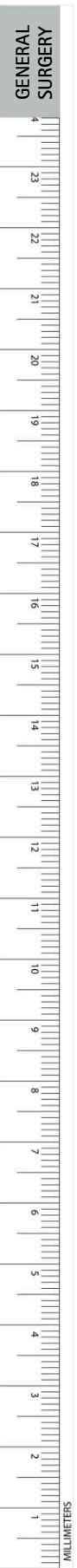

LLOYD-DAVIES Rectal Scissors

| Catalog Number | Tip | Blade | Length (in.) |
|----------------|-----|-------|--------------|
| BC621R | B/B | CVD | 10 5/8 |

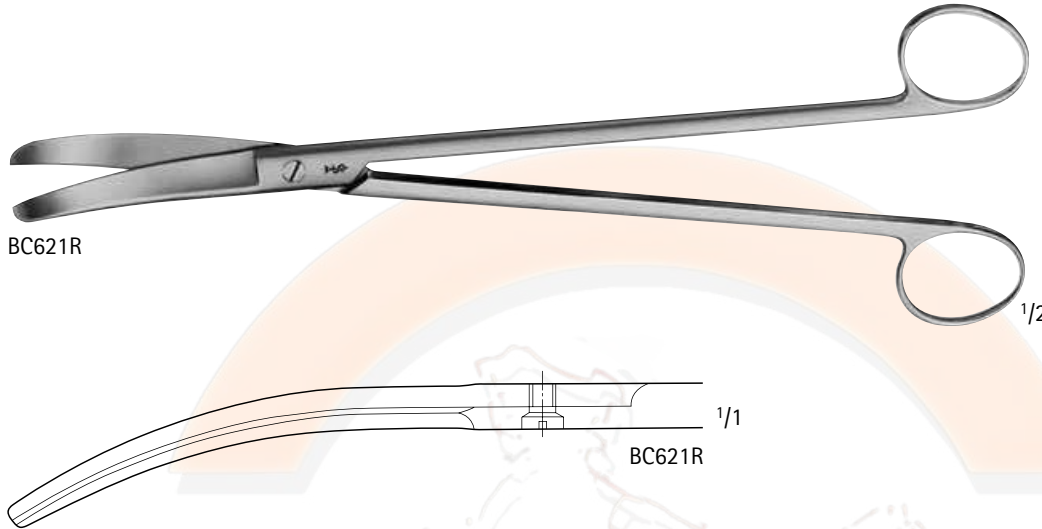

STELZNER Rectal Scissors

| Catalog Number | Tip | Blade | Length (in.) |
|----------------|-----|-------|--------------|
| BC622R | B/B | STR | 12 1/4 |
| BC623R | B/B | CVD | 12 1/4 |

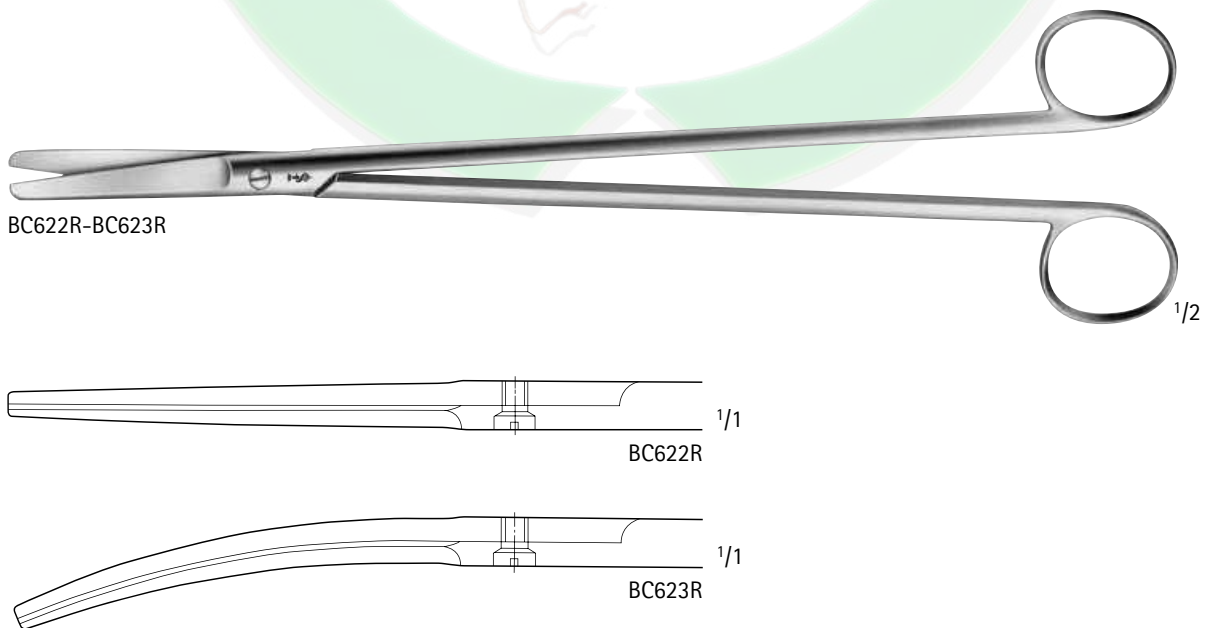



GENERAL SURGERY SCISSORS

MUELLER Rectal Scissors

| Catalog Number | Tip | Blade | Length (in.) |
|----------------|-----|-------|--------------|
| BC627R | B/B | CVD | 12 3/4 |



BC627R

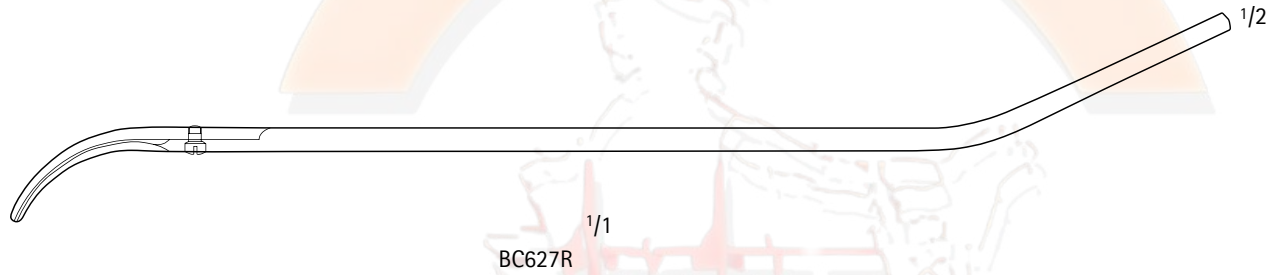

BC627R

HARVEY Wire Scissors

| Catalog Number | Tip | Blade | Length (in.) |
|----------------|-----|-------|--------------|
| BC815R | B/B | SERR | 5 |



BC815R

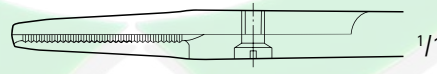

BC815R



DP551R

Wire Cutting Scissors

| Catalog Number | For Wire Size | Length (in.) |
|----------------|--|--------------|
| DP551R | SOFT, UP TO 1.2MM AND HARD, UP TO 0.6 MM | 4 3/4 |

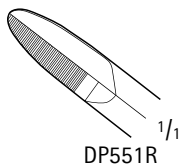

DP551R

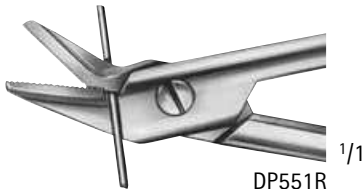

DP551R

GENERAL SURGERY





GENERAL SURGERY DELICATE SCISSORS



BC064R-BC065R

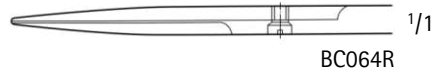

BC064R

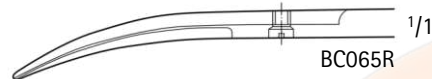

BC065R

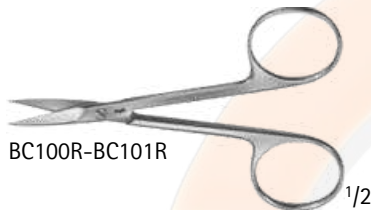

BC100R-BC101R

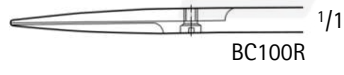

BC100R

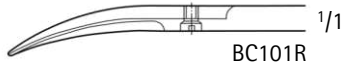

BC101R

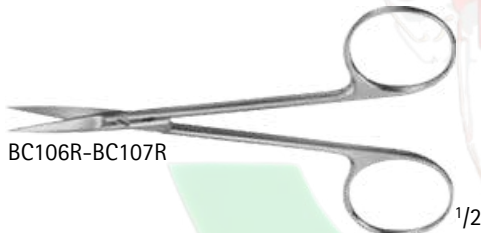

BC106R-BC107R

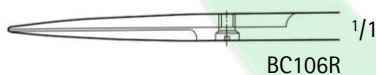

BC106R

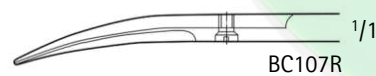

BC107R

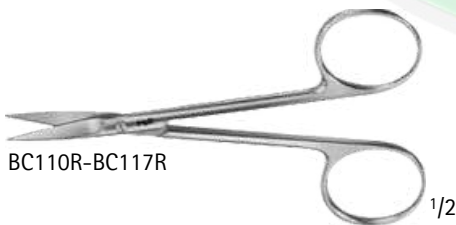

BC110R-BC117R

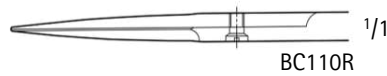

BC110R

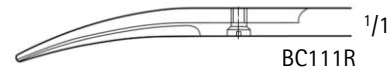

BC111R

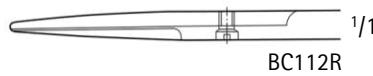

BC112R

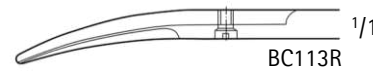

BC113R

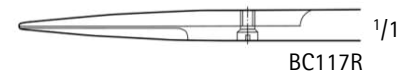

BC117R



BC117R

Iris Scissors

| Catalog Number | Tip | Blade | Length (in.) |
|----------------|-----|---------|--------------|
| BC100R | S/S | STR | 3 1/2 |
| BC110R | S/S | STR | 4 1/4 |
| BC106R | S/S | STR | 4 1/2 |
| BC064R | S/S | STR | 4 3/4 |
| BC101R | S/S | CVD | 3 1/2 |
| BC111R | S/S | CVD | 4 1/4 |
| BC107R | S/S | CVD | 4 1/2 |
| BC065R | S/S | CVD | 4 3/4 |
| BC112R | S/B | STR | 4 1/4 |
| BC113R | S/B | CVD | 4 1/4 |
| BC117R | S/S | LAT-ANG | 4 1/4 |



GENERAL SURGERY DELICATE SCISSORS

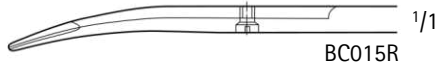

REYNOLDS-JAMESON Tenotomy Scissors

| Catalog Number | Tip | Blade | Handle | Length (in.) |
|----------------|-----|-------|--------|--------------|
| BC015R | B/B | CVD | SQUARE | 5 1/2 |

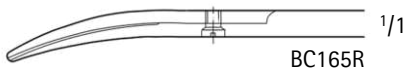
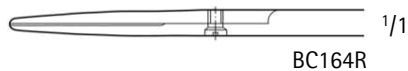

Strabismus Scissors

| Catalog Number | Tip | Blade | Length (in.) |
|----------------|-----|-------|--------------|
| BC164R | B/B | STR | 4 1/2 |
| BC165R | B/B | CVD | 4 1/2 |

GENERAL SURGERY





AMRAMED[®]
TECH Pvt. Ltd.

Wholesale Supplier

A to Z Hospital Equipment and
Surgical Products B to C



Certified Register

GENERAL SURGERY DELICATE SCISSORS

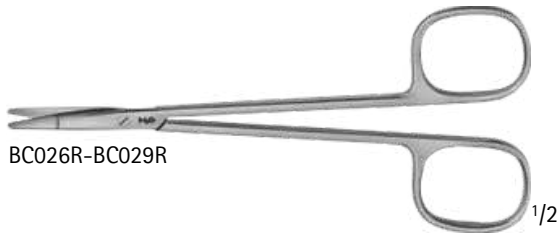

RAGNELL Dissecting Scissors

| Catalog Number | Tip | Blade | Length (in.) |
|----------------|-----|-------|--------------|
| BC026R | B/B | STR | 5 1/4 |
| BC027R | B/B | CVD | 5 1/4 |
| BC029R | B/B | CVD | 6 |

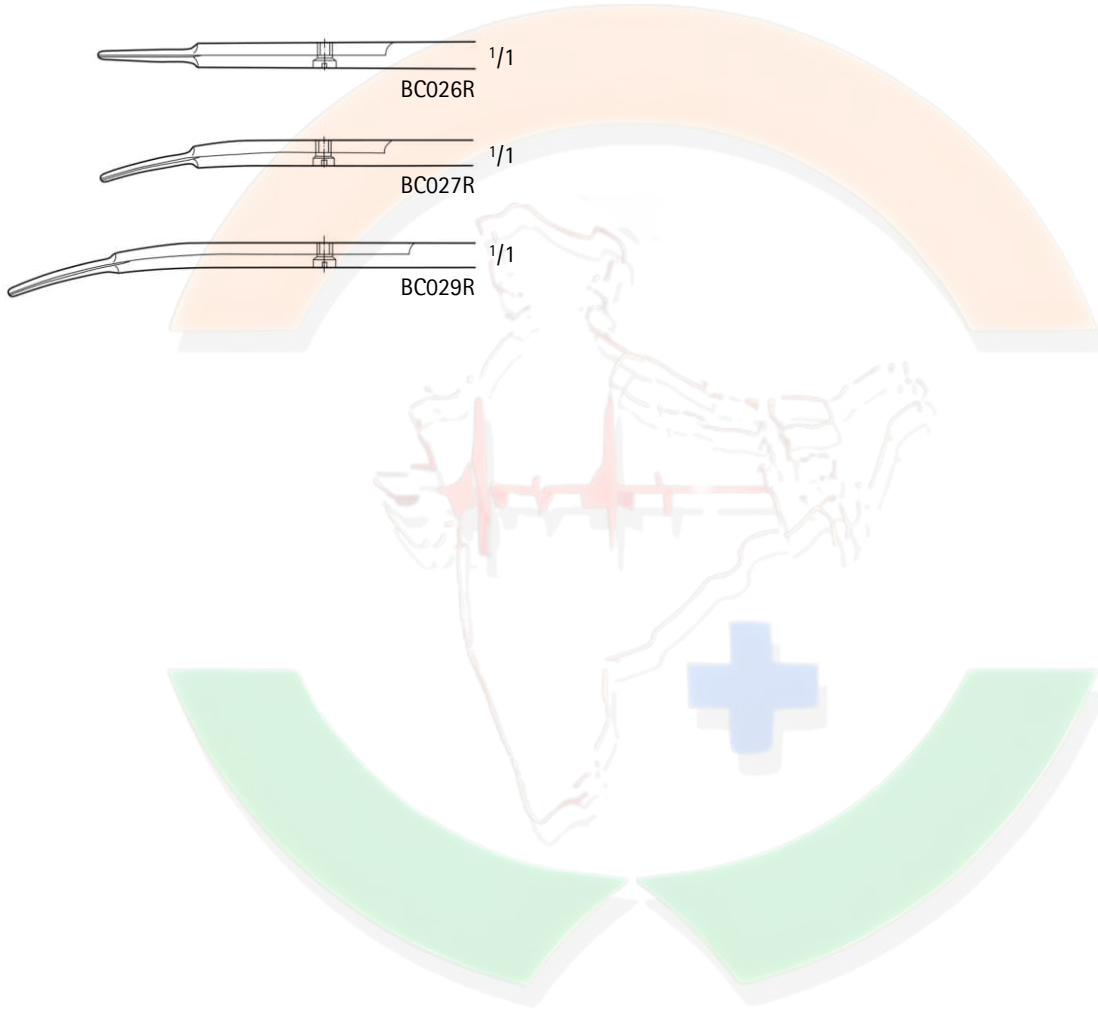



GENERAL SURGERY DELICATE SCISSORS



BC153R

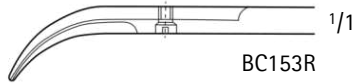

BC153R

CHADWICK Scissors, Delicate

| Catalog Number | Tip | Blade | Length (in.) |
|----------------|-----|-------|--------------|
| BC153R | S/S | CVD | 4 1/2 |



BC154R

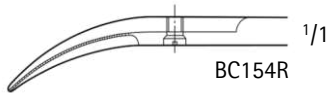

BC154R

LA GRANGE Scissors

| Catalog Number | Tip | Blade | Length (in.) |
|----------------|-----|--------|--------------|
| BC154R | S/S | 1-SERR | 4 1/4 |



BC160R-BC161R

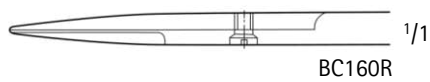

BC160R

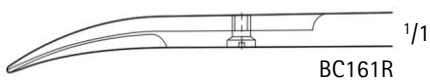

BC161R

KELLY Scissors

| Catalog Number | Tip | Blade | Length (in.) |
|----------------|-----|-------|--------------|
| BC160R | S/S | STR | 6 7/8 |
| BC161R | S/S | CVD | 6 7/8 |





AMRAMED[®]
TECH Pvt. Ltd.

Wholesale Supplier

A to Z Hospital Equipment and
Surgical Products B to C



Certified Register

GENERAL SURGERY DELICATE SCISSORS



ROCHESTER-FERGUSON Scissors

| Catalog Number | Tip | Blade | Length (in.) |
|----------------|-----|----------|--------------|
| MG220R | B/B | ANG FLAT | 7 |

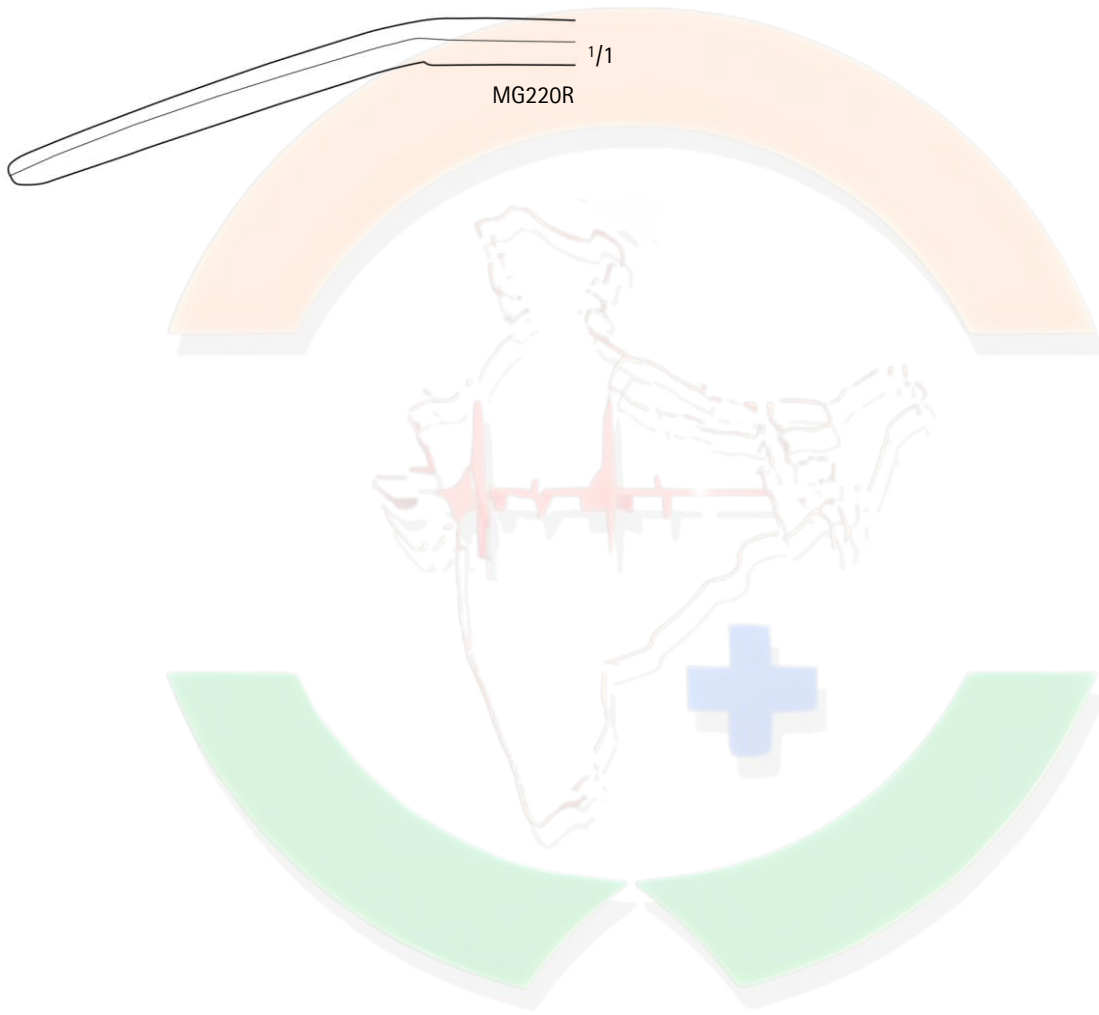



GENERAL SURGERY DUROTIP™ TC SCISSORS

DUROTIP Tungsten Carbide Scissors

- Excellent cutting accuracy
- Long working life
- Gold-plated rings



BC228R



BC228R



BC224R-BC234R

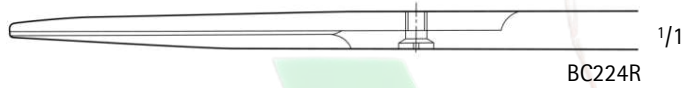

BC224R

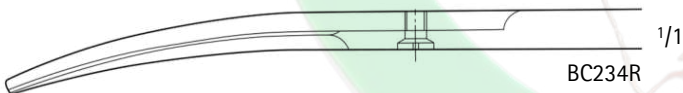

BC234R

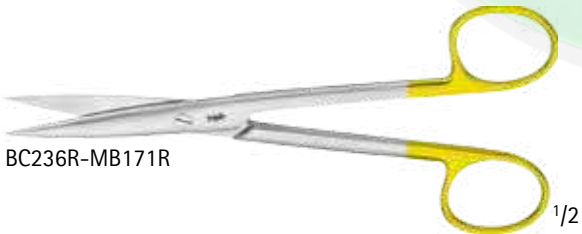

BC236R-MB171R

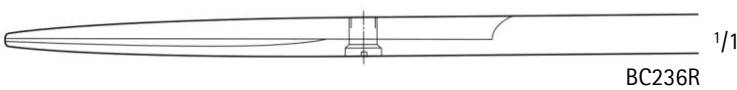

BC236R



MB171R

DUROTIP TC Suture Scissors

| Catalog Number | Tip | Blade | Length (in.) |
|----------------|-----|-------|--------------|
| BC228R | S/S | STR | 5 3/4 |
| BC224R | S/B | STR | 5 3/4 |
| BC234R | S/B | CVD | 5 3/4 |

DUROTIP TC Operating Scissors

| Catalog Number | Tip | Blade | Length (in.) |
|----------------|-----|-------|--------------|
| BC236R | S/S | STR | 5 3/4 |
| MB171R | S/S | CVD | 5 3/4 |





GENERAL SURGERY DUROTIP™ TC SCISSORS

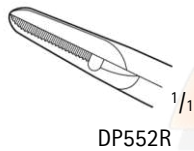
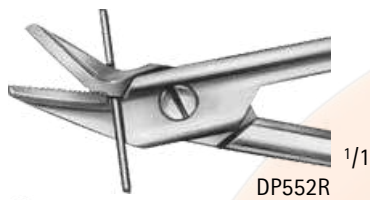

DUROTIP TC Wire Cutting Scissors

| Catalog Number | Blade | For Wire Size | Length (in.) |
|----------------|--------|---|--------------|
| DP552R | 1-SERR | SOFT, UP TO 1.2 MM AND HARD, UP TO 0.8 MM | 4 3/4 |

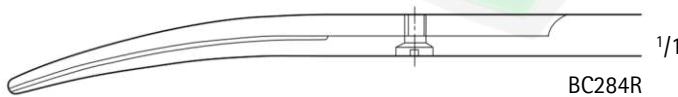
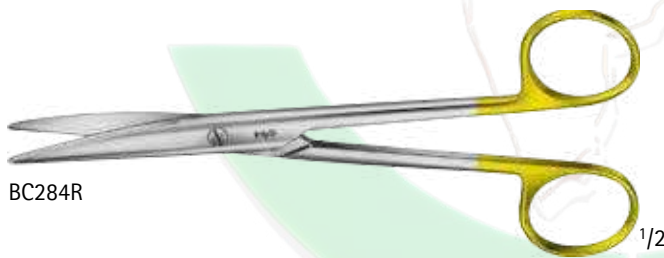

DUROTIP TC MAYO-LEXER Dissecting Scissors, Round Blades

| Catalog Number | Tip | Blade | Length (in.) |
|----------------|-----|-------|--------------|
| BC284R | B/B | CVD | 6 1/2 |

GENERAL SURGERY DUROTIP™ TC SCISSORS



BC240R-BC243R

**DUROTIP TC MAYO Dissecting Scissors,
Round Blades**

| Catalog Number | Tip | Blade | Length (in.) |
|----------------|-----|-------|--------------|
| BC240R | B/B | STR | 5 1/2 |
| BC242R | B/B | STR | 6 3/4 |
| BC241R | B/B | CVD | 5 1/2 |
| BC243R | B/B | CVD | 6 3/4 |

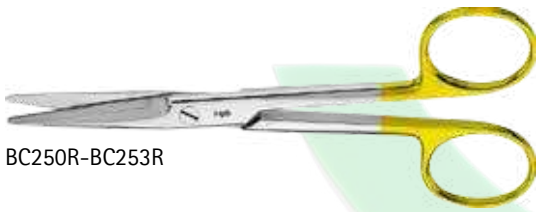
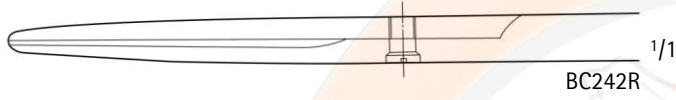
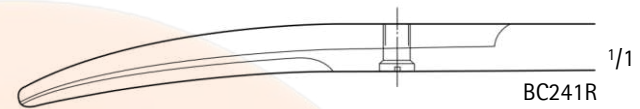
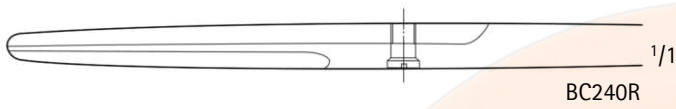

BC250R-BC253R

**DUROTIP TC MAYO Dissecting Scissors,
Beveled Blades**

| Catalog Number | Tip | Blade | Length (in.) |
|----------------|-----|-------|--------------|
| BC250R | B/B | STR | 5 1/2 |
| BC252R | B/B | STR | 6 3/4 |
| BC251R | B/B | CVD | 5 1/2 |
| BC253R | B/B | CVD | 6 3/4 |

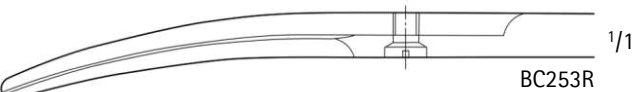
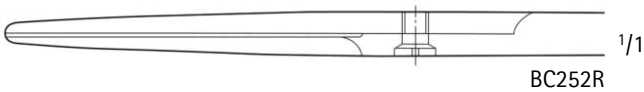
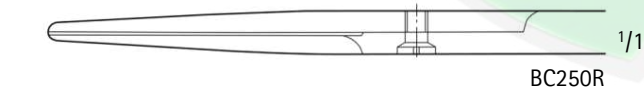



AMRAMED
TECH Pvt. Ltd.

Wholesale Supplier

A to Z Hospital Equipment and
Surgical Products B to C



Certified Register

GENERAL SURGERY DUROTIP™ TC SCISSORS

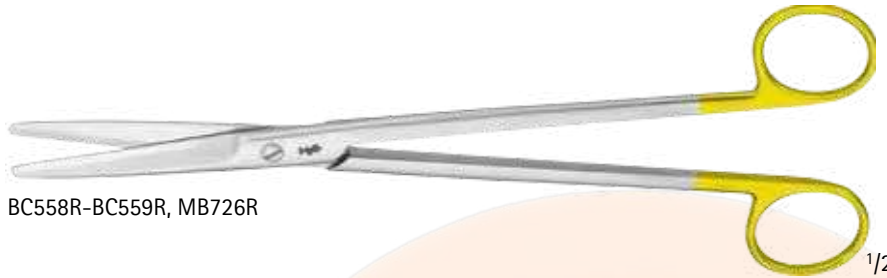

BC558R-BC559R, MB726R

DUROTIP TC MAYO Dissecting Scissors

| Catalog Number | Tip | Blade | Length (in.) |
|----------------|-----|-------|--------------|
| BC558R | B/B | STR | 9 |
| MG215R | B/B | STR | 14 |
| BC559R | B/B | CVD | 9 |
| MB726R | B/B | CVD | 14 |



BC558R

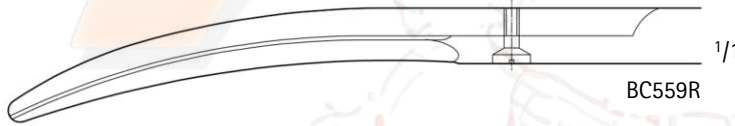

BC559R



MB726R

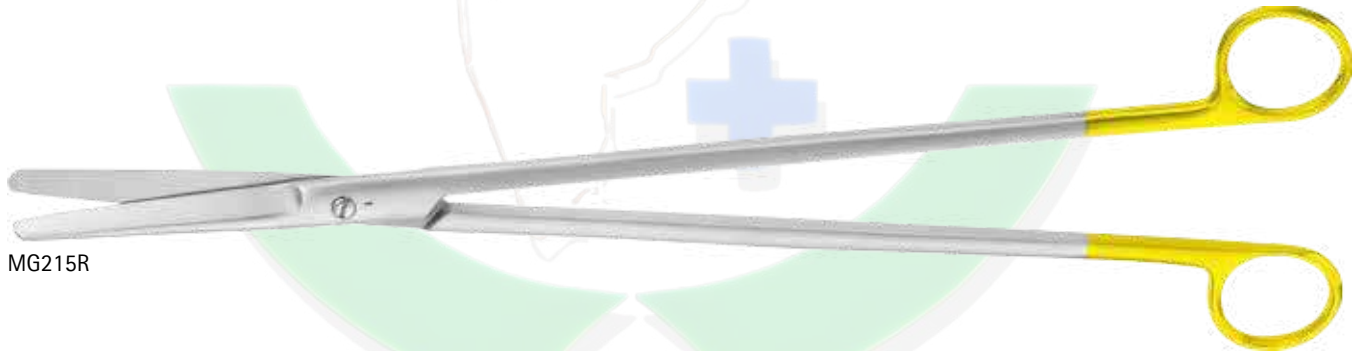

MG215R



MG215R



GENERAL SURGERY DUROTIP™ TC SCISSORS

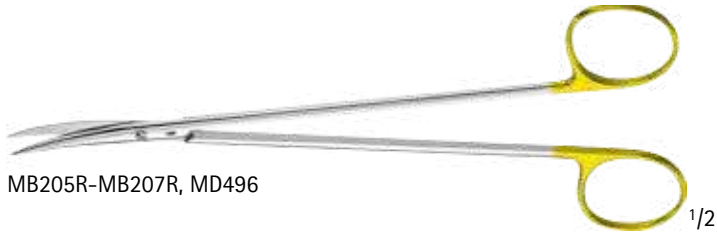

MB205R-MB207R, MD496

DUROTIP TC METZENBAUM Dissecting Scissors, Delicate

| Catalog Number | Tip | Blade | Length (in.) |
|----------------|-----|-------|--------------|
| MB205R | S/S | STR | 9 1/4 |
| MB207R | S/S | CVD | 5 3/4 |
| MD496 | S/S | CVD | 7 |
| MB206R | S/S | CVD | 9 1/4 |



MB205R

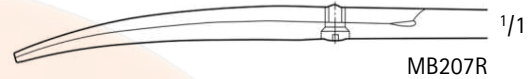

MB207R

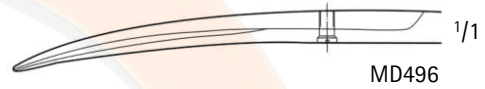

MD496



MB206R

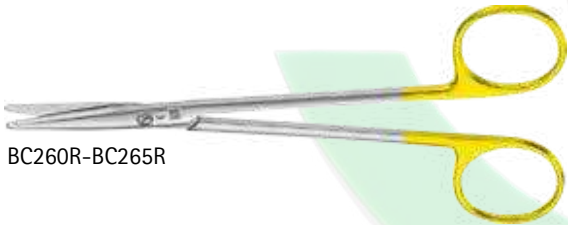

BC260R-BC265R

DUROTIP TC METZENBAUM Dissecting Scissors

| | Tip | Catalog NuBlade | Length (in.) |
|--------|-----|-----------------|--------------|
| BC260R | B/B | STR | 5 3/4 |
| BC262R | B/B | STR | 7 |
| BC261R | B/B | CVD | 5 3/4 |
| BC263R | B/B | CVD | 7 |
| BC265R | B/B | CVD | 7 7/8 |

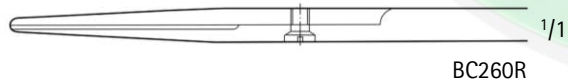

BC260R

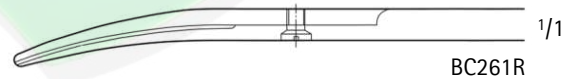

BC261R

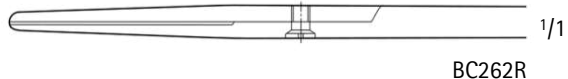

BC262R

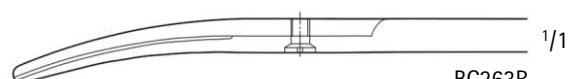

BC263R

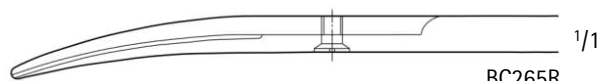

BC265R





GENERAL SURGERY DUROTIP™ TC SCISSORS

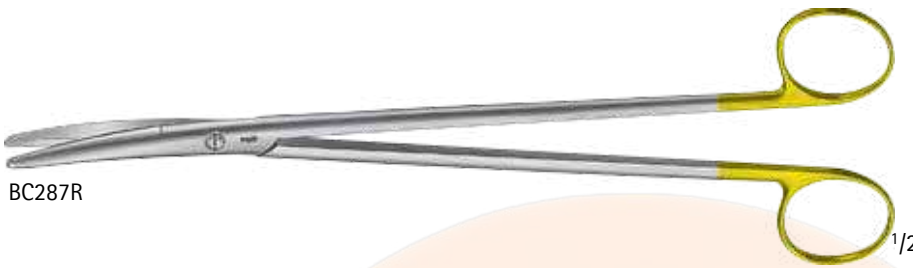

BC287R

DUROTIP TC METZENBAUM Dissecting Scissors

| Catalog Number | Tip | Blade | Length (in.) |
|----------------|-----|-------|--------------|
| BC287R | B/B | CVD | 9 |



BC287R



BC270R-BC277R

DUROTIP TC METZENBAUM Dissecting Scissors, Delicate

| Catalog Number | Tip | Blade | Length (in.) |
|----------------|-----|-------|--------------|
| BC270R | B/B | STR | 7 |
| BC274R | B/B | STR | 7 7/8 |
| BC276R | B/B | STR | 9 |
| BC271R | B/B | CVD | 7 |
| BC275R | B/B | CVD | 7 7/8 |
| BC277R | B/B | CVD | 9 |



BC270R



BC274R

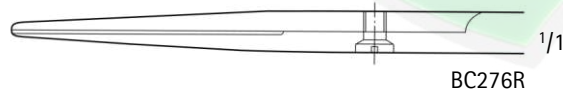

BC276R



BC271R

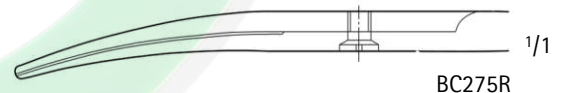

BC275R



BC277R



GENERAL SURGERY DUROTIP™ TC SCISSORS



BC258R-BC259R

**DUROTIP TC Baby METZENBAUM
Dissecting Scissors, Delicate**

| Catalog Number | Tip | Blade | Length (in.) |
|----------------|-----|-------|--------------|
| BC258R | B/B | STR | 5 3/4 |
| BC259R | B/B | CVD | 5 3/4 |

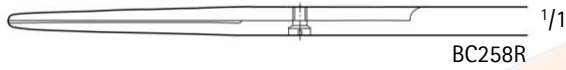

BC258R

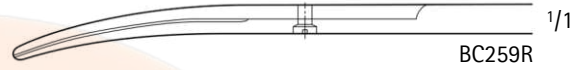

BC259R

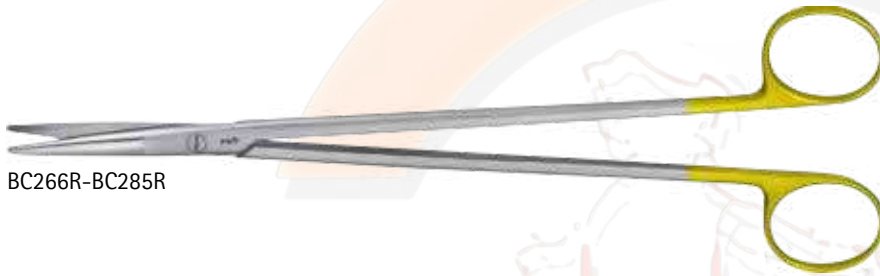

BC266R-BC285R

**DUROTIP TC NELSON-METZENBAUM
Dissecting Scissors**

| Catalog Number | Tip | Blade | Length (in.) |
|----------------|-----|-------|--------------|
| BC266R | B/B | STR | 9 |
| BC267R | B/B | CVD | 9 |
| BC279R | B/B | CVD | 10 1/4 |
| BC281R | B/B | CVD | 11 |
| BC282R | B/B | CVD | 11 1/4 |
| BC289R | B/B | CVD | 11 3/4 |
| BC285R | B/B | CVD | 13 3/4 |



BC266R

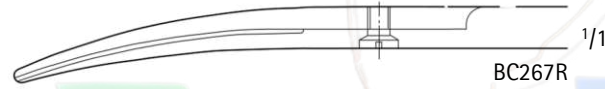

BC267R

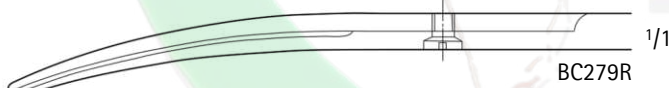

BC279R

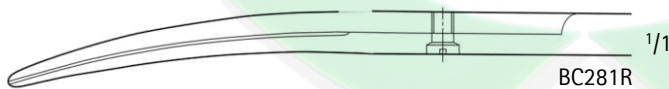

BC281R

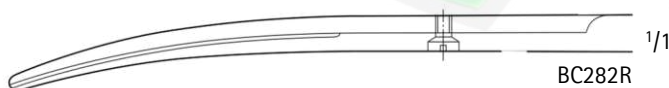

BC282R

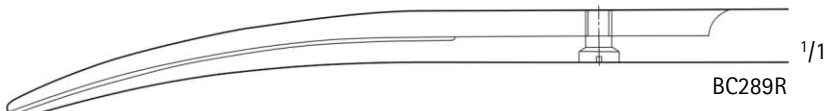

BC289R

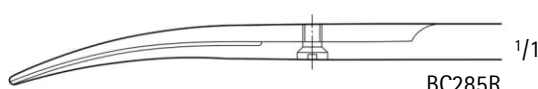

BC285R

GENERAL SURGERY





GENERAL SURGERY DUROTIP™ TC SCISSORS

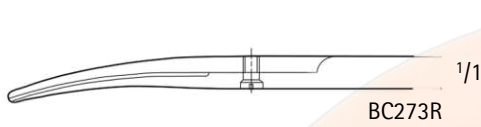

DUROTIP TC TOENNIS-ADSON
Dissecting Scissors, Delicate

| Catalog Number | Tip | Blade | Length (in.) |
|----------------|-----|-------|--------------|
| BC273R | B/B | CVD | 6 7/8 |

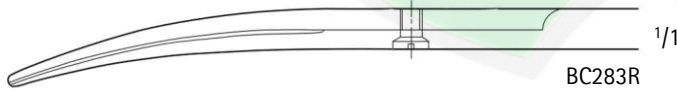
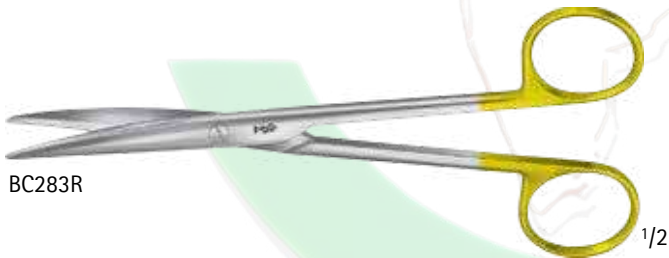

DUROTIP TC LEXER Dissecting Scissors,
Delicate

| Catalog Number | Tip | Blade | Length (in.) |
|----------------|-----|-------|--------------|
| BC283R | B/B | CVD | 6 1/2 |



GENERAL SURGERY DUROTIP™ TC SCISSORS



Wavecut

■ Wavecut scissors have one serrated cutting edge to prevent tissue from slipping.

The W after the item number indicates the scissors are the wavecut style, e.g. BC211W.



BC253W

DUROTIP TC MAYO Wavecut Dissecting Scissors, Beveled Blades

| Catalog Number | Tip | Blade | Length (in.) |
|----------------|-----|-------|--------------|
| BC253W | B/B | CVD | 6 3/4 |

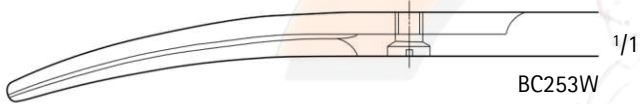

BC253W



BC259W

DUROTIP TC Baby METZENBAUM Wavecut Dissecting Scissors, Delicate

| Catalog Number | Tip | Blade | Length (in.) |
|----------------|-----|-------|--------------|
| BC259W | B/B | CVD | 5 3/4 |

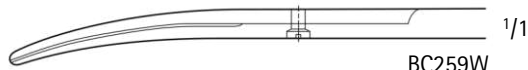

BC259W

GENERAL SURGERY





GENERAL SURGERY DUROTIP™ TC SCISSORS



BC261W-BC265W



BC261W 1/1

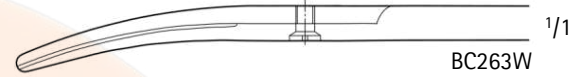

BC263W 1/1

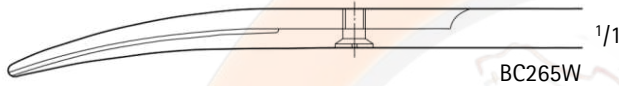

BC265W 1/1



BC271W-BC277W

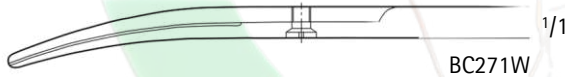

BC271W 1/1

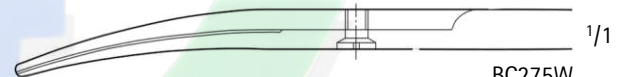

BC275W 1/1

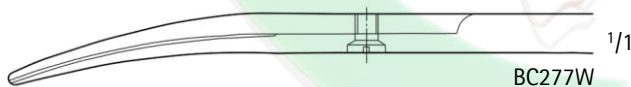

BC277W 1/1



BC287W

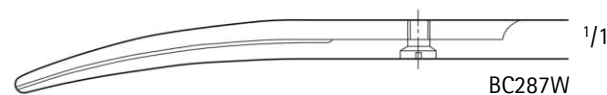

BC287W 1/1

DUROTIP TC METZENBAUM Wavecut Dissecting Scissors

| Catalog Number | Tip | Blade | Length (in.) |
|----------------|-----|-------|--------------|
| BC261W | B/B | CVD | 5 3/4 |
| BC263W | B/B | CVD | 7 |
| BC265W | B/B | CVD | 7 7/8 |

DUROTIP TC METZENBAUM Wavecut Dissecting Scissors, Delicate

| Catalog Number | Tip | Blade | Length (in.) |
|----------------|-----|-------|--------------|
| BC271W | B/B | CVD | 7 |
| BC275W | B/B | CVD | 7 7/8 |
| BC277W | B/B | CVD | 9 |

DUROTIP TC METZENBAUM Wavecut Dissecting Scissors, Heavy

| Catalog Number | Tip | Blade | Length (in.) |
|----------------|-----|-------|--------------|
| BC287W | B/B | CVD | 9 |



GENERAL SURGERY DUROTIP™ TC SCISSORS



BC273W

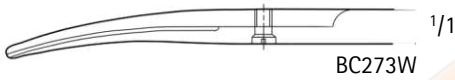

BC273W

**DUROTIP TC TOENNIS-ADSON Wavecut
Dissecting Scissors**

| Catalog Number | Tip | Blade | Length (in.) |
|----------------|-----|-------|--------------|
| BC273W | B/B | CVD | 6 7/8 |



BC267W

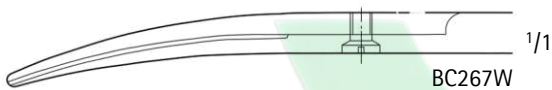

BC267W

**DUROTIP TC NELSON-METZENBAUM
Wavecut Dissecting Scissors**

| Catalog Number | Tip | Blade | Length (in.) |
|----------------|-----|-------|--------------|
| BC267W | B/B | CVD | 9 |
| BC279W | B/B | CVD | 10 1/4 |
| BC281W | B/B | CVD | 11 |



BC279W-BC281W

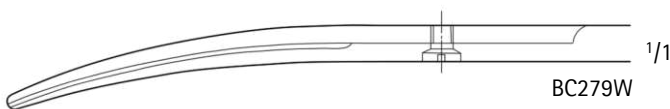

BC279W

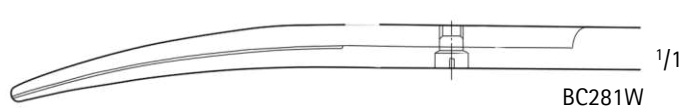

BC281W





AMRAMED
TECH Pvt. Ltd.

Wholesale Supplier

A to Z Hospital Equipment and
Surgical Products B to C



Certified Register

GENERAL SURGERY DUROTIP™ TC SCISSORS



BC284W

1/2

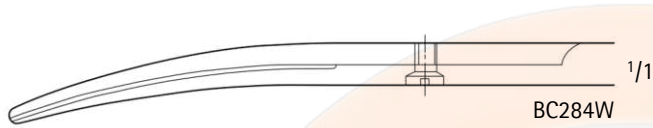

BC284W

1/1

**DUROTIP TC MAYO-LEXER Wavecut
Scissors**

| Catalog Number | Tip | Blade | Length (in.) |
|----------------|-----|-------|--------------|
| BC284W | B/B | CVD | 6 1/2 |

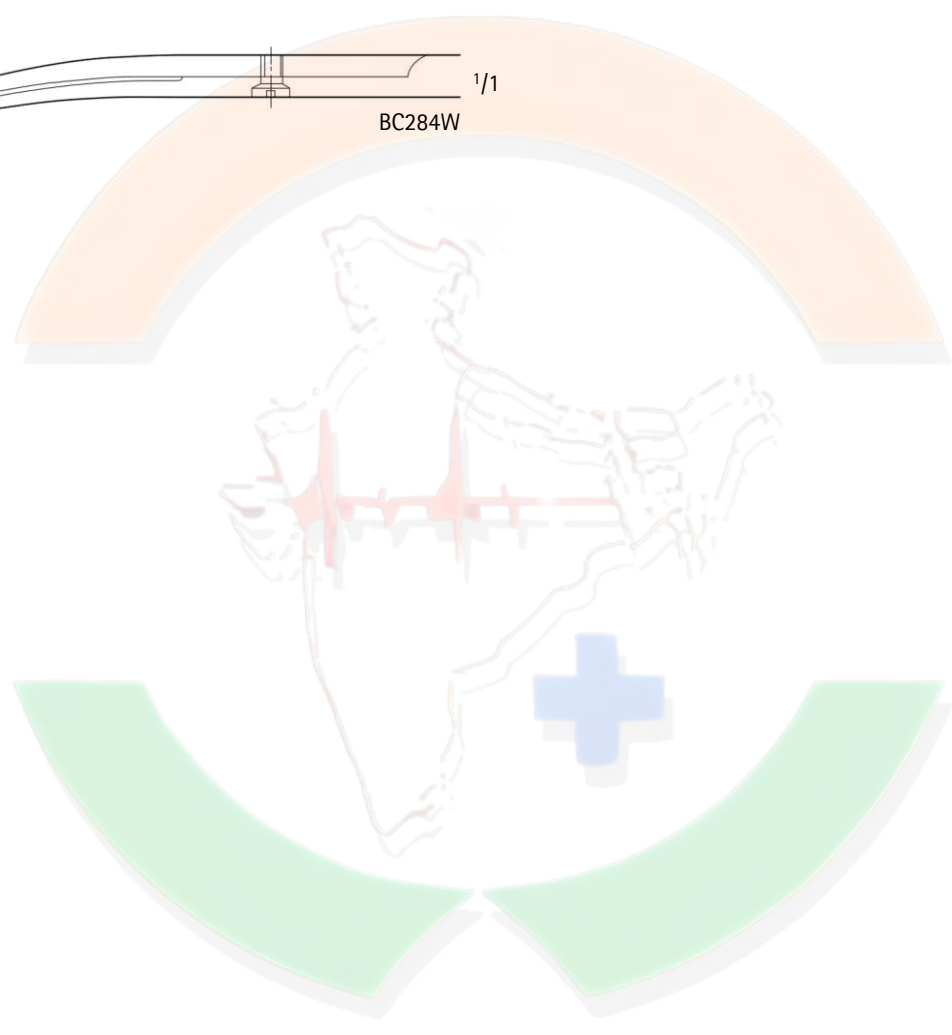



GENERAL SURGERY DUROTIP™ TC SCISSORS

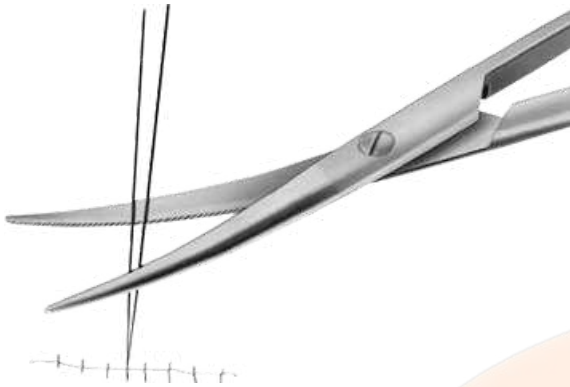

DUROTIP TC Ligature Scissors

■ Carbide inserts guarantee permanent sharp cutting edge

(also in the distal area of the blades).

■ Wavecut prevents suture materials from slipping.

■ Identified by 1 gold-plated ring.



BC294W-BC298W

DUROTIP TC Ligature Wavecut Scissors

| Catalog Number | Tip | Blade | Length (in.) |
|----------------|-----|-------|--------------|
| BC294W | B/B | CVD | 5 3/4 |
| BC295W | B/B | CVD | 7 |
| BC296W | B/B | CVD | 9 |
| BC297W | B/B | CVD | 10 1/4 |
| BC298W | B/B | CVD | 13 3/4 |

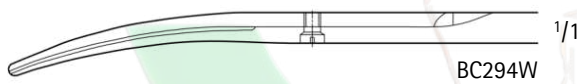

BC294W

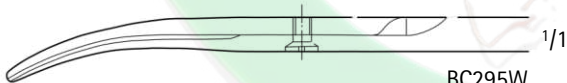

BC295W

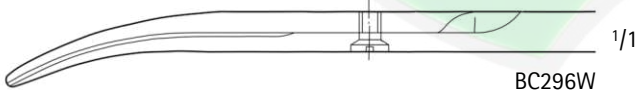

BC296W

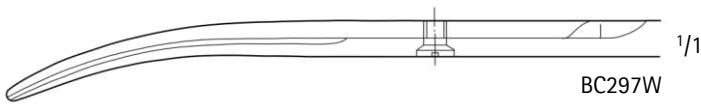

BC297W

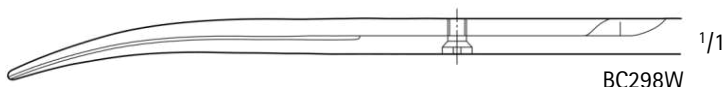

BC298W

GENERAL SURGERY





GENERAL SURGERY SUPERCUT SCISSORS

SuperCut Scissors

Your everyday black handle scissors

■ Microtome Edge

- Razor sharp cutting edge facilitates gentle cutting with minimal force
- Wavecut Blade
- Prevents tissue from slipping out during the cutting process

For more information about SuperCut Scissors see brochure number DOC821.



BC900R-BC901R

Iris SuperCut Scissors, Delicate

| Catalog Number | Tip | Blade | Length (in.) |
|----------------|-----|-------|--------------|
| BC900R | S/S | STR | 4 1/4 |
| BC901R | S/S | CVD | 4 1/4 |

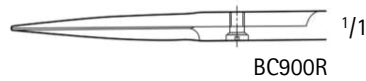

BC900R



BC901R



BC903R

SuperCut Plastic Standard Scissors

| Catalog Number | Tip | Blade | Length (in.) |
|----------------|-----|-------|--------------|
| BC903R | S/S | CVD | 5 |

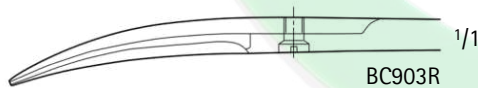

BC903R



BC904R-BC905R

STEVENS SuperCut Scissors

| Catalog Number | Tip | Tip Size (mm) | Blade | Length (in.) |
|----------------|-----|---------------|-------|--------------|
| BC904R | B/B | 12 | STR | 4 1/8 |
| BC905R | B/B | 12 | CVD | 4 1/8 |

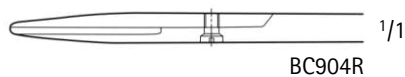

BC904R

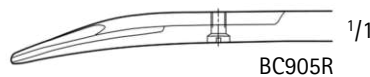

BC905R





GENERAL SURGERY SUPERCUT SCISSORS



BC906R-BC907R

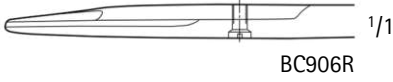

BC906R



BC907R

STEVENS SuperCut Scissors (continued)

| Catalog Number | Tip | Tip Size (mm) | Blade | Length (in.) |
|----------------|-----|---------------|-------|--------------|
| BC906R | B/B | 13 | STR | 4 1/4 |
| BC907R | B/B | 13 | CVD | 4 1/4 |



BC909R

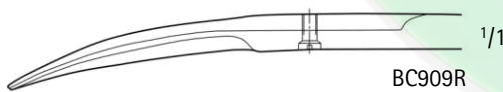

BC909R

GOLDMANN-FOX SuperCut Scissors

| Catalog Number | Tip | Blade | Length (in.) |
|----------------|-----|-------|--------------|
| BC909R | S/S | CVD | 5 1/8 |





GENERAL SURGERY SUPERCUT SCISSORS



BC911R



BC911R

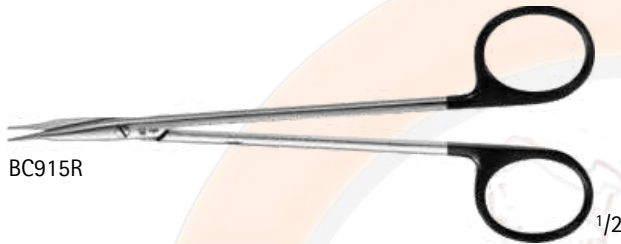

BC915R



BC915R



BC919R

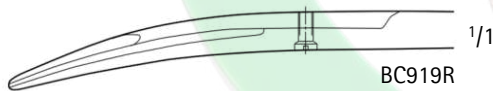

BC919R



BC916R-BC917R

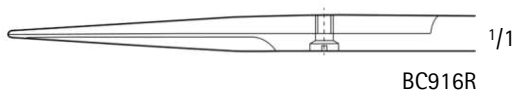

BC916R

JAMESON SuperCut Scissors, Delicate

| Catalog Number | Tip | Blade | Length (in.) |
|----------------|-----|-------|--------------|
| BC911R | B/B | CVD | 5 1/8 |
| BC915R | B/B | CVD | 6 |
| BC919R | B/B | CVD | 7 |

JOSEPH SuperCut Scissors, Delicate

| Catalog Number | Tip | Blade | Length (in.) |
|----------------|-----|-------|--------------|
| BC916R | S/S | STR | 6 |
| BC917R | S/S | CVD | 6 |

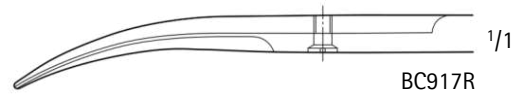

BC917R



GENERAL SURGERY SUPERCUT SCISSORS



BC920R-BC921R

GORNEY SuperCut Scissors, Delicate

| Catalog Number | Tip | Blade | Length (in.) |
|----------------|-----|-------|--------------|
| BC920R | B/B | STR | 7 3/4 |
| BC921R | B/B | CVD | 7 3/4 |

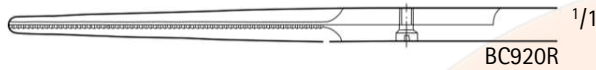

BC920R

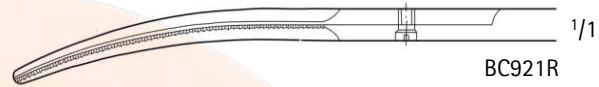

BC921R



BC933R

KAYE SuperCut Facelift Scissors, Delicate

| Catalog Number | Tip | Blade | Length (in.) |
|----------------|-----|-------|--------------|
| BC933R | B/B | CVD | 7 3/4 |

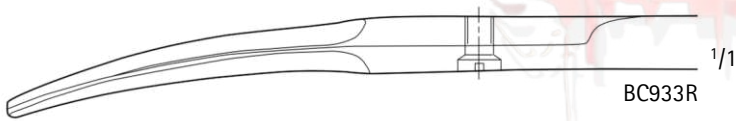

BC933R



BC926R-BC927R

MAYO SuperCut Scissors, Delicate

| Catalog Number | Tip | Blade | Length (in.) |
|----------------|-----|--------------|--------------|
| BC926R | B/B | STR, BEVELED | 5 3/4 |
| BC927R | B/B | CVD, BEVELED | 5 3/4 |
| BC924R | B/B | STR, ROUND | 6 1/2 |
| BC925R | B/B | CVD, ROUND | 6 1/2 |

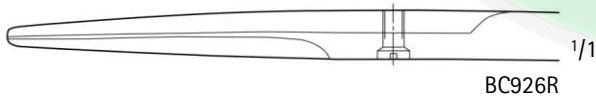

BC926R



BC927R



BC924R-BC925R

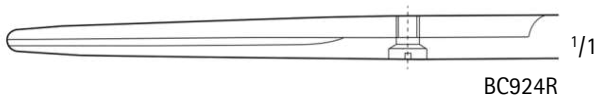

BC924R

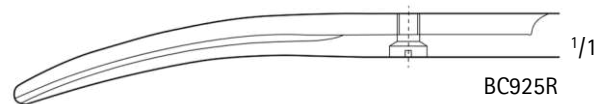

BC925R





GENERAL SURGERY SUPERCUT SCISSORS

MAYO SuperCut Scissors, Beveled

| Catalog Number | Tip | Blade | Length (in.) |
|----------------|-----|-------|--------------|
| MG216R | B/B | STR | 9 |
| BC922R | B/B | STR | 10 |
| BC938R | B/B | STR | 12 |
| MG087R | B/B | CVD | 9 |
| BC929R | B/B | CVD | 11 |

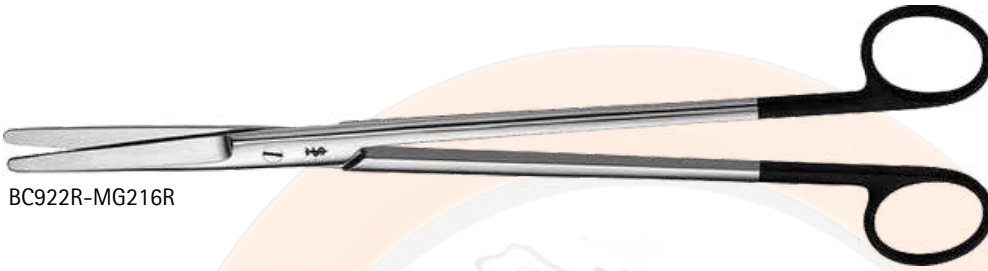

BC922R-MG216R

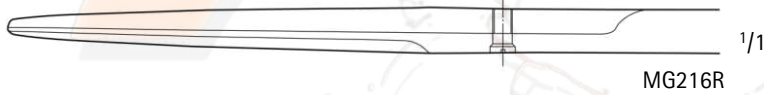

MG216R 1/1



BC922R 1/1

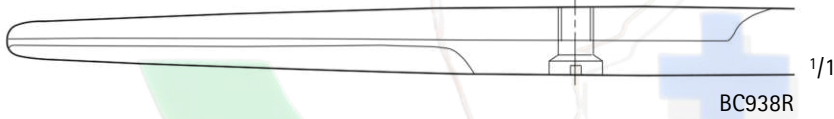

BC938R 1/1

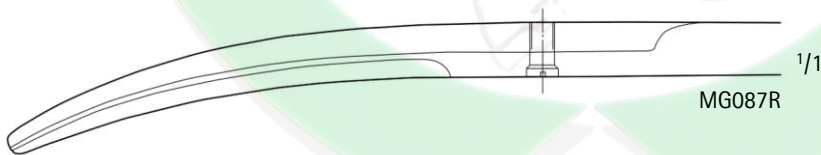

MG087R 1/1



BC929R 1/1





GENERAL SURGERY SUPERCUT SCISSORS



BC930R-BC931R

**Baby METZENBAUM SuperCut
Scissors, Delicate**

| Catalog Number | Tip | Blade | Length (in.) |
|----------------|-----|-------|--------------|
| BC930R | B/B | STR | 4 1/2 |
| BC931R | B/B | CVD | 4 1/2 |

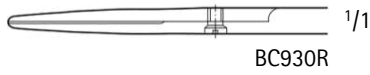

BC930R

1/1

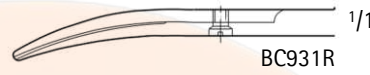

BC931R

1/1

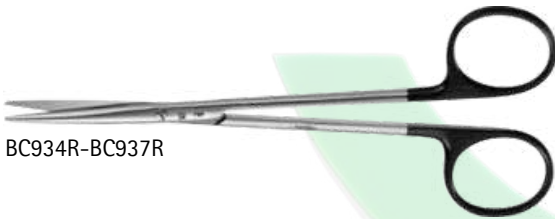

BC934R-BC937R

**METZENBAUM SuperCut Scissors,
Delicate**

| Catalog Number | Tip | Blade | Length (in.) |
|----------------|-----|-------|--------------|
| BC934R | B/B | STR | 5 3/4 |
| BC936R | B/B | STR | 7 |
| BC935R | B/B | CVD | 5 3/4 |
| BC937R | B/B | CVD | 7 |



BC934R

1/1



BC935R

1/1

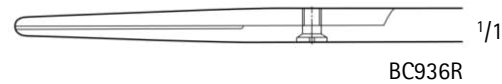

BC936R

1/1

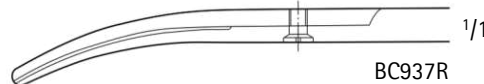

BC937R

1/1





GENERAL SURGERY SUPERCUT SCISSORS



BC945R-BC953R

METZENBAUM SuperCut Scissors, Delicate

| Catalog Number | Tip | Blade | Length (in.) |
|----------------|-----|-------|--------------|
| BC945R | B/B | CVD | 9 |
| BC947R | B/B | CVD | 10 1/4 |
| BC949R | B/B | CVD | 11 1/4 |
| BC951R | B/B | CVD | 11 3/4 |
| BC953R | B/B | CVD | 14 |

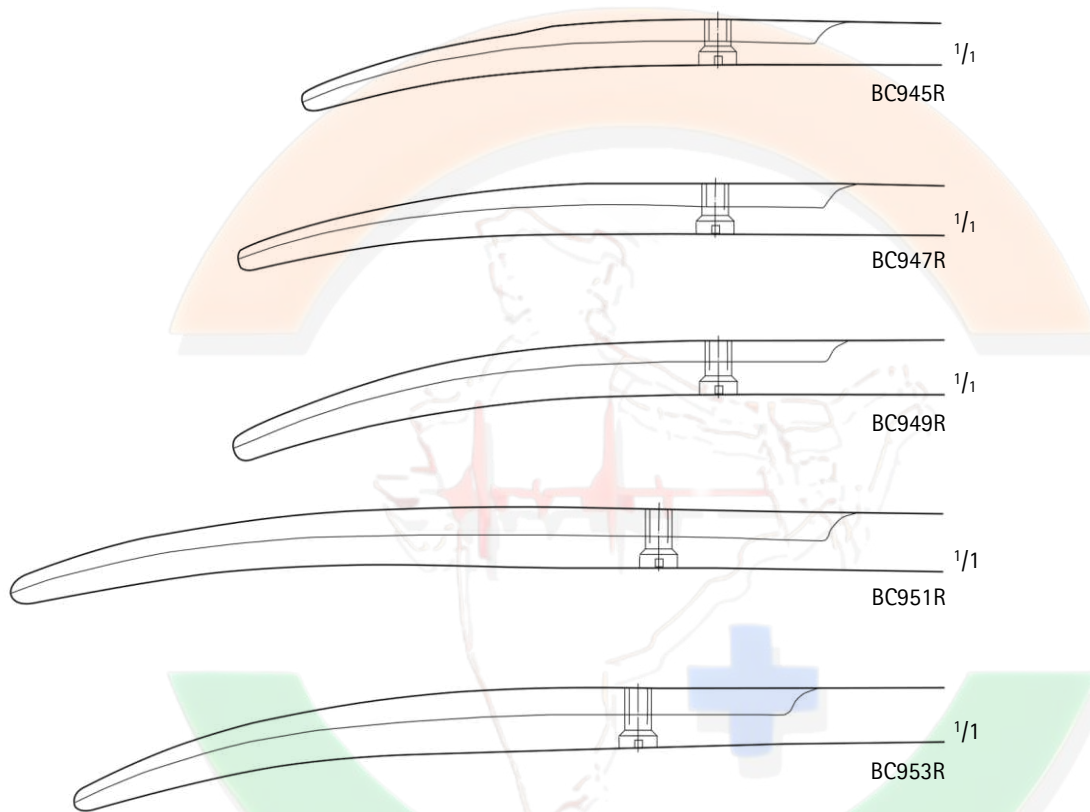

BC957R-BC959R

POTTS-SMITH SuperCut Scissors

| Catalog Number | Tip | Blade Angle | Blade Size (mm) | Length (in.) |
|----------------|-----|-------------|-----------------|--------------|
| BC957R | B/B | 25° | 22 | 7 1/2 |
| BC958R | B/B | 45° | 20 | 7 1/4 |
| BC959R | B/B | 60° | 19 | 7 |



BC957R



BC958R



BC959R

GENERAL SURGERY NOIR™ SUPREME CUT SCISSORS

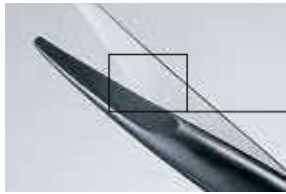

Microtome Edge

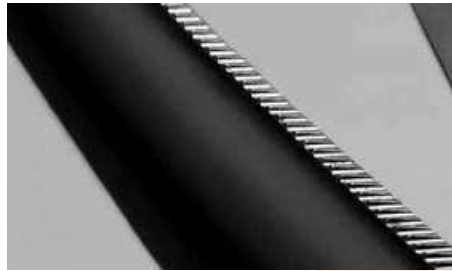

Wavecut

Noir Supreme Cut Scissors

■ **Noir**

The combination of the renowned Aesculap Tungsten Carbide technology with the Aesculap Noir coating results in an extremely high surface hardness and therefore high wear resistance in daily hospital use.

■ **Microtome edge**

The extremely sharp cutting edge of the scissors blade facilitates gentle cutting of tissue with minimal use of force.

■ **Wavecut prevents tissue from slipping out during the cutting process.**

■ **The WB after the item number indicates the Noir scissors are the wavecut style, e.g. BC211WB.**

For more information about Noir Supreme Cut Scissors see our brochure number DOC637.



BC252B-BC253WB

Noir MAYO Dissecting Scissors

| Catalog Number | Tip | Blade | Length (in.) |
|----------------|-----|-------|--------------|
| BC252B | B/B | STR | 6 3/4 |
| BC253B | B/B | CVD | 6 3/4 |
| BC253WB | B/B | CVD | 6 3/4 |



BC252B



BC253B, BC253WB



BC284B-BC284WB

Noir MAYO-LEXER Dissecting Scissors

| Catalog Number | Tip | Blade | Length (in.) |
|----------------|-----|-------|--------------|
| BC284B | B/B | CVD | 6 1/2 |
| BC284WB | B/B | CVD | 6 1/2 |



BC284B-BC284WB





GENERAL SURGERY NOIR™ SUPREME CUT SCISSORS

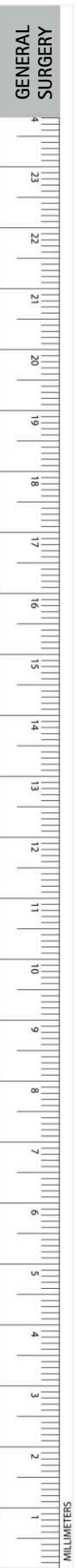

Noir LEXER Dissecting Scissors

| Catalog Number | Tip | Blade | Length (in.) |
|----------------|-----|----------|--------------|
| BC283B | B/B | DEL, CVD | 6 1/2 |
| BC283WB | B/B | DEL, CVD | 6 1/2 |



Noir Iris Dissecting Scissors

| Catalog Number | Tip | Blade | Length (in.) |
|----------------|-----|-------|--------------|
| BC210B | S/S | STR | 4 1/4 |
| BC211B | S/S | CVD | 4 1/4 |
| BC211WB | S/S | CVD | 4 1/4 |



Noir TOENNIS-ADSON Dissecting Scissors

| Catalog Number | Tip | Blade | Length (in.) |
|----------------|-----|----------|--------------|
| BC273B | B/B | DEL, CVD | 6 7/8 |
| BC273WB | B/B | DEL, CVD | 6 7/8 |





GENERAL SURGERY NOIR™ SUPREME CUT SCISSORS



BC261B-BC277WB



BC261B, BC261WB

1/1



BC263B, BC263WB

1/1



BC271B, BC271WB

1/1



BC265B, BC265WB

1/1



BC275B, BC275WB

1/1



BC267B, BC267WB

1/1



BC277B, BC277WB

1/1

Noir METZENBAUM Dissecting Scissors

| Catalog Number | Tip | Blade | Length (in.) |
|----------------|-----|----------|--------------|
| BC261B | B/B | CVD | 5 3/4 |
| BC261WB | B/B | CVD | 5 3/4 |
| BC263B | B/B | CVD | 7 |
| BC263WB | B/B | CVD | 7 |
| BC271B | B/B | DEL, CVD | 7 |
| BC271WB | B/B | DEL, CVD | 7 |
| BC265B | B/B | CVD | 7 7/8 |
| BC265WB | B/B | CVD | 7 7/8 |
| BC275B | B/B | DEL, CVD | 7 7/8 |
| BC275WB | B/B | DEL, CVD | 7 7/8 |
| BC267B | B/B | CVD | 9 |
| BC267WB | B/B | CVD | 9 |
| BC277B | B/B | DEL, CVD | 9 |
| BC277WB | B/B | DEL, CVD | 9 |

GENERAL SURGERY





GENERAL SURGERY NOIR™ SUPREME CUT SCISSORS

**Noir NELSON-METZENBAUM
Dissecting Scissors**

| Catalog Number | Tip | Blade | Length (in.) |
|----------------|-----|----------|--------------|
| BC279B | B/B | DEL, CVD | 10 1/4 |
| BC279WB | B/B | DEL, CVD | 10 1/4 |
| BC281B | B/B | DEL, CVD | 11 |
| BC281WB | B/B | DEL, CVD | 11 |



GENERAL SURGERY NEEDLE HOLDERS



BM200R



BM200R

CONVERSE Needle Holder

| Catalog Number | Jaw | Length (in.) |
|----------------|-----------|--------------|
| BM200R | LONG SERR | 5 1/8 |

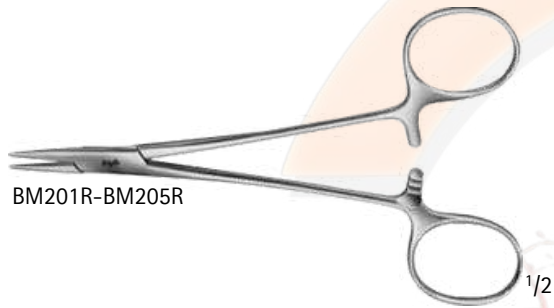

BM201R-BM205R



BM201R

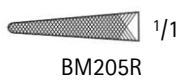

BM205R

HALSEY Needle Holder

| Catalog Number | Tip | Jaw | Length (in.) |
|----------------|-----|--------|--------------|
| BM201R | DEL | SMOOTH | 5 1/8 |
| BM205R | DEL | X-SERR | 5 1/8 |

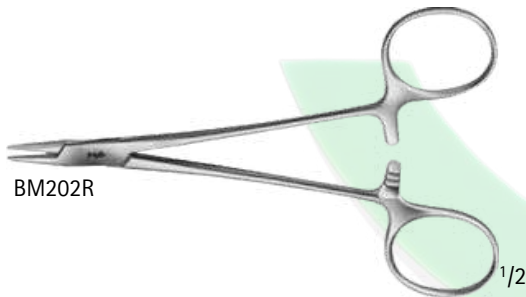

BM202R



BM202R

WEBSTER Needle Holder

| Catalog Number | Jaw | Length (in.) |
|----------------|--------|--------------|
| BM202R | SMOOTH | 5 |



BM204R



BM204R

DERF Needle Holder

| Catalog Number | Jaw | Length (in.) |
|----------------|------|--------------|
| BM204R | SERR | 5 |





GENERAL SURGERY NEEDLE HOLDERS



BM210R

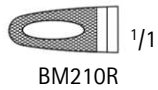

BM210R

DOYEN Needle Holder

| Catalog Number | Jaw | Length (in.) |
|----------------|--------|--------------|
| BM210R | X-SERR | 5 |



MG366R

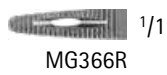

MG366R

COLLIER Needle Holder, Fenestrated

| Catalog Number | Jaw | Length (in.) |
|----------------|------|--------------|
| MG366R | SERR | 5 |

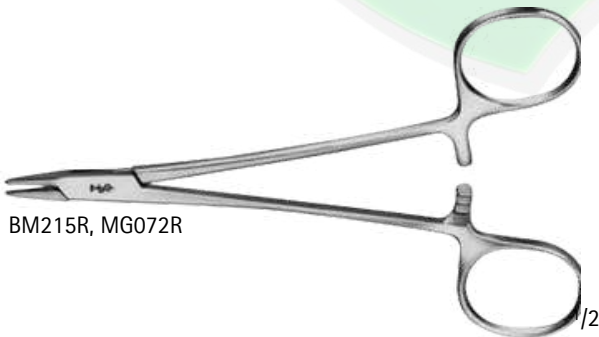

BM215R, MG072R



MG072R

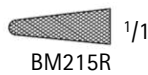

BM215R

BAUMGARTNER Needle Holder

| Catalog Number | Jaw | Length (in.) |
|----------------|---------------|--------------|
| MG072R | SERR, GROOVED | 5 1/4 |
| BM215R | X-SERR | 5 3/4 |



GENERAL SURGERY NEEDLE HOLDERS

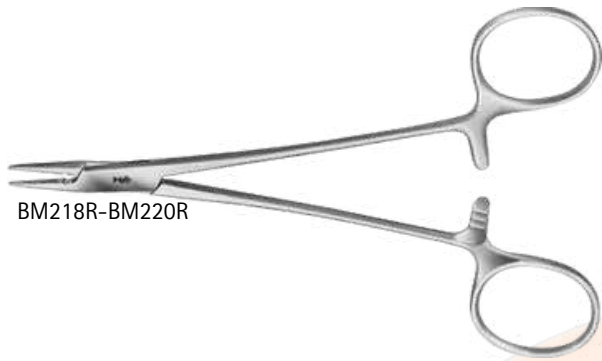

BM218R-BM220R

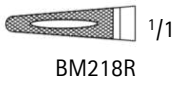

BM218R

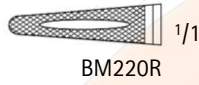

BM220R

CRILE-WOOD Needle Holder

| Catalog Number | Jaw | Length (in.) |
|----------------|--------|--------------|
| BM218R | X-SERR | 6 |
| BM220R | X-SERR | 6 1/4 |



BM219R

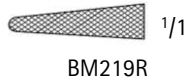

BM219R

CRILE-MURRAY Needle Holder

| Catalog Number | Jaw | Length (in.) |
|----------------|------|--------------|
| BM219R | SERR | 6 |

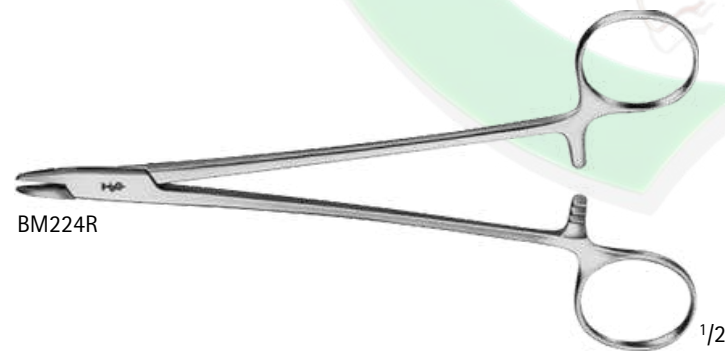

BM224R



BM224R

ADSON Needle Holder, Fenestrated

| Catalog Number | Jaw | Length (in.) |
|----------------|------|--------------|
| BM224R | SERR | 7 |



1/1





GENERAL SURGERY NEEDLE HOLDERS

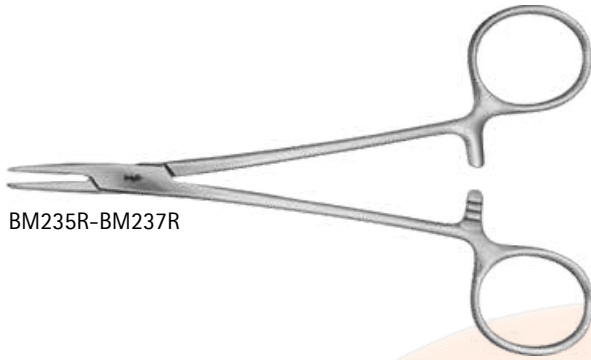

BM235R-BM237R



BM235R



BM236R



BM237R

MAYO-HEGAR Needle Holder

| Catalog Number | Jaw | Length (in.) |
|----------------|--------|--------------|
| BM235R | X-SERR | 6 |
| BM236R | X-SERR | 7 1/4 |
| BM237R | X-SERR | 7 7/8 |



BM245R-BM255R

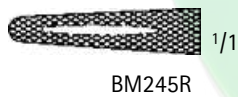

BM245R

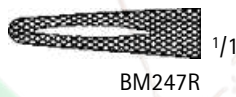

BM247R



BM249R



BM255R

HEGAR Needle Holder

| Catalog Number | Tip | Jaw | Length (in.) |
|----------------|-------|--------|--------------|
| BM245R | HEAVY | X-SERR | 6 |
| BM247R | HEAVY | X-SERR | 6 7/8 |
| BM249R | HEAVY | X-SERR | 8 |
| BM255R | HEAVY | X-SERR | 8 |

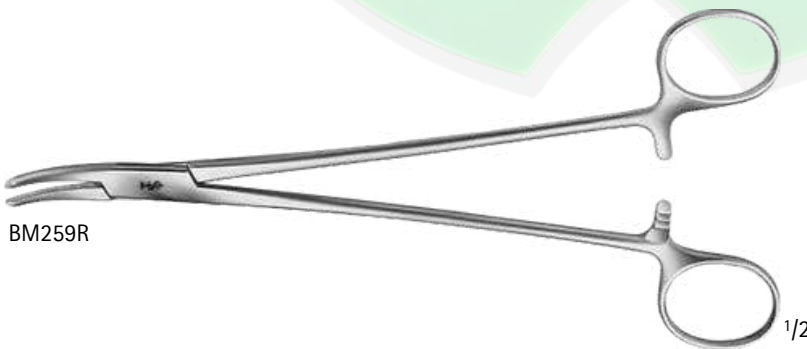

BM259R

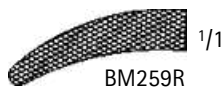

BM259R

HEANEY Needle Holder

| Catalog Number | Tip | Jaw | Length (in.) |
|----------------|-----|------|--------------|
| BM259R | CVD | SERR | 7 7/8 |



GENERAL SURGERY NEEDLE HOLDERS

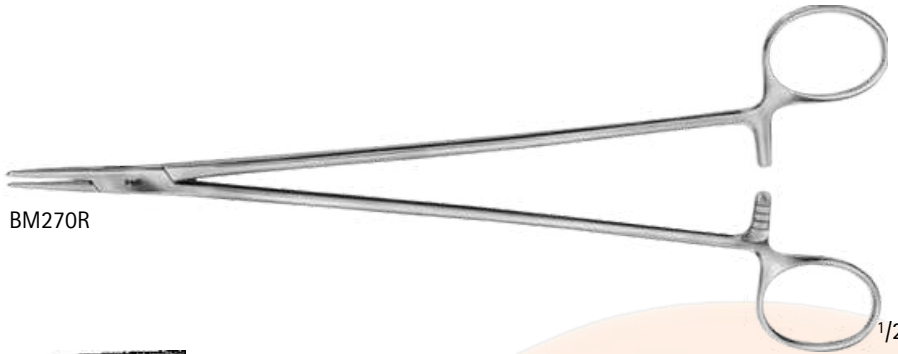

BM270R



BM270R

JAMESON Needle Holder

| Catalog Number | Tip | Jaw | Length (in.) |
|----------------|-----|--------|--------------|
| BM270R | DEL | X-SERR | 9 |

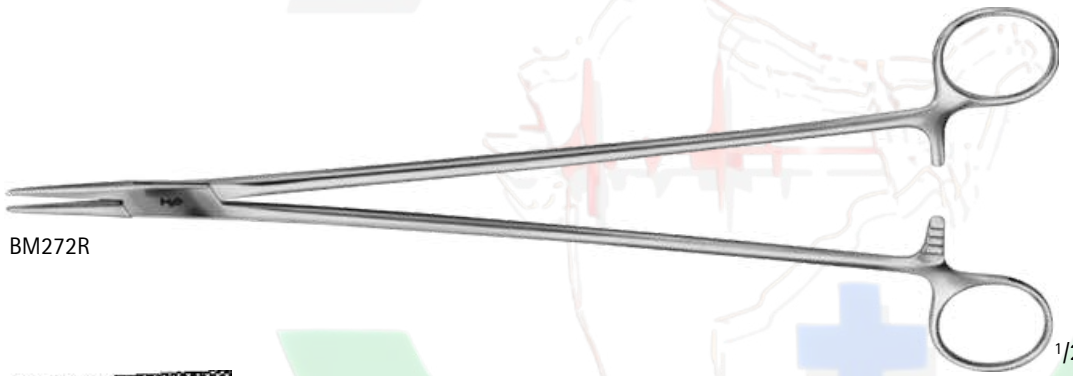

BM272R



BM272R

WANGENSTEEN Needle Holder

| Catalog Number | Jaw | Length (in.) |
|----------------|--------|--------------|
| BM272R | X-SERR | 10 3/4 |

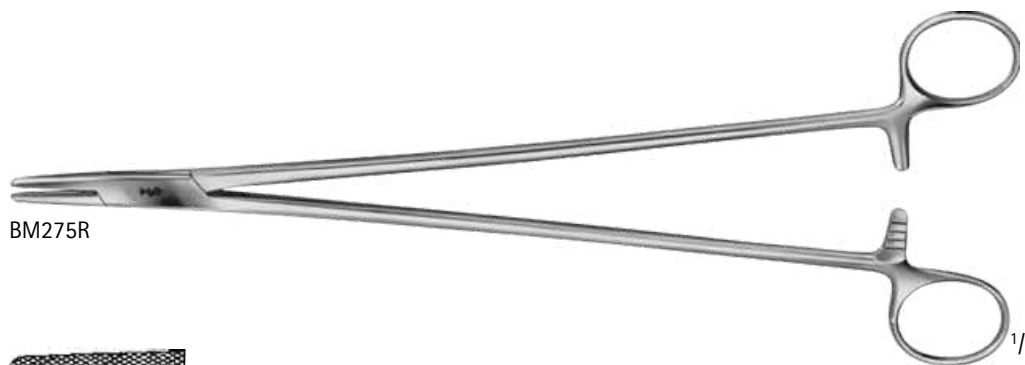

BM275R



BM275R

MASSON Needle Holder

| Catalog Number | Jaw | Length (in.) |
|----------------|--------|--------------|
| BM275R | X-SERR | 10 1/2 |





GENERAL SURGERY NEEDLE HOLDERS

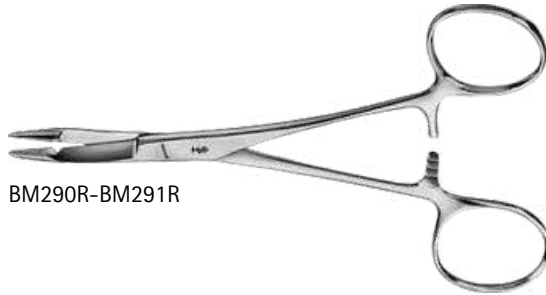

BM290R-BM291R

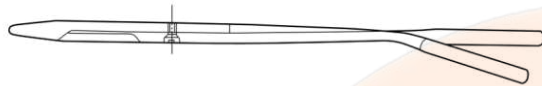

BM290R

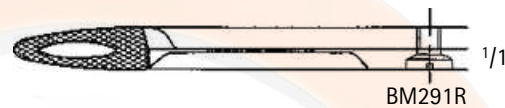

BM291R

HEGAR-OLSEN Needle Holder/Scissors

| Catalog Number | Jaw | Length (in.) |
|----------------|------|--------------|
| BM290R | SERR | 5 1/2 |
| BM291R | SERR | 7 1/4 |



BM299R

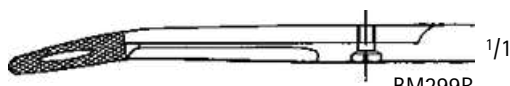

BM299R

GILLIES Needle Holder/Scissors

| Catalog Number | Jaw | Length (in.) |
|----------------|------|--------------|
| BM299R | SERR | 6 1/4 |



GENERAL SURGERY DUROGRIP™ TC NEEDLE HOLDERS

Aesculap features Needle Holders with Tungsten Carbide (TC) inserts. A smooth jaw and three different serration patterns are available, depending on the size of the suture needle.



smooth



0.2

(16,000 teeth/in.2)



0.4

(4,000 teeth/in.2)



0.5

(2,500 teeth/in.2)

We recommend carbide inserts as follows:

Jaw Surface Smooth 0.2 mm pitch of serration 0.4 mm pitch of serration 0.5 mm pitch of serration

Suture Material
9/0 - 11/0
6/0 - 10/0
4/0 - 6/0
up to 3/0

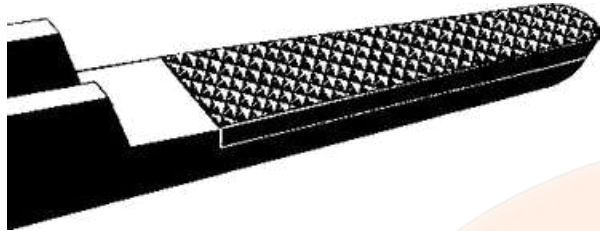

BM320R

DUROGRIP TC HELLBERG-KUPKA Needle Holder W/ Ergonomic Handle

| Catalog Number | Jaw | Length (in.) |
|----------------|------|--------------|
| BM320R | SERR | 8 1/4 |



BM320R



BM008R

DUROGRIP TC DERF Needle Holder

| Catalog Number | Jaw | Length (in.) |
|----------------|------|--------------|
| BM008R | SERR | 4 3/4 |

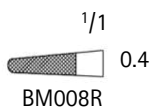

BM008R





GENERAL SURGERY DUROGRIP™ TC NEEDLE HOLDERS

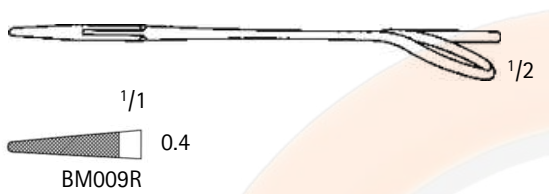

DUROGRIP TC MASING Needle Holder

| Catalog Number | Jaw | Length (in.) |
|----------------|------|--------------|
| BM009R | SERR | 5 1/8 |



DUROGRIP TC HALSEY Needle Holder

| Catalog Number | Jaw | Length (in.) |
|----------------|--------|--------------|
| BM010R | SMOOTH | 4 3/4 |
| BM012R | SERR | 5 1/8 |

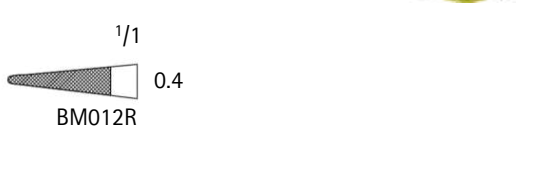



GENERAL SURGERY DUROGRIP™ TC NEEDLE HOLDERS



BM011R

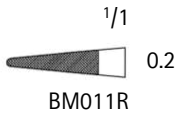

DUROGRIP TC CONVERSE Needle Holder

| Catalog Number | Jaw | Length (in.) |
|----------------|------|--------------|
| BM011R | SERR | 5 1/8 |



BM014R-BM024R



DUROGRIP TC WEBSTER Needle Holder

| Catalog Number | Jaw | Length (in.) |
|----------------|--------|--------------|
| BM014R | SMOOTH | 5 1/8 |
| BM024R | SERR | 5 1/8 |



BM015R

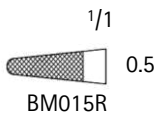

DUROGRIP TC BAUMGARTNER Needle Holder

| Catalog Number | Jaw | Length (in.) |
|----------------|------|--------------|
| BM015R | SERR | 5 3/4 |





GENERAL SURGERY DUROGRIP™ TC NEEDLE HOLDERS

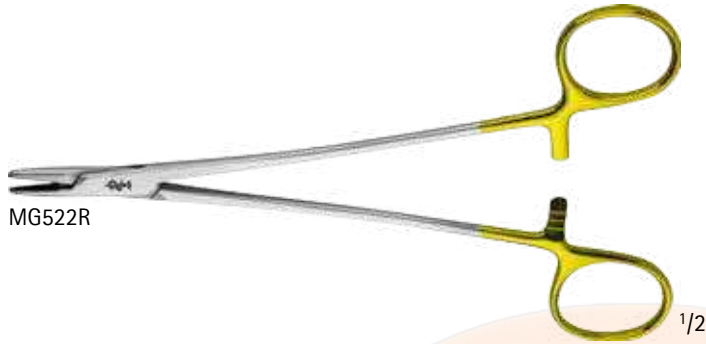

MG522R



MG522R

DUROGRIP TC NEW ORLEANS Needle Holder

| Catalog Number | Jaw | Length (in.) |
|----------------|------|--------------|
| MG522R | SERR | 7 |



BM020R-BM023R

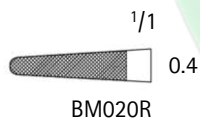

BM020R

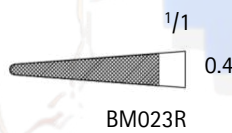

BM023R

DUROGRIP TC SAROT Needle Holder

| Catalog Number | Jaw | Length (in.) |
|----------------|------|--------------|
| BM020R | SERR | 7 |
| BM023R | SERR | 10 1/4 |



BM013R

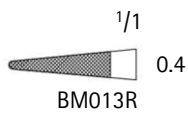

BM013R

DUROGRIP TC Baby CRILE-WOOD Needle Holder

| Catalog Number | Jaw | Length (in.) |
|----------------|------|--------------|
| BM013R | SERR | 6 |



GENERAL SURGERY DUROGRIP™ TC NEEDLE HOLDERS



BM016R, BM021R, MB604R

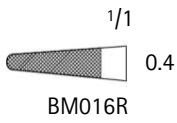

BM016R

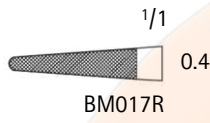

BM017R

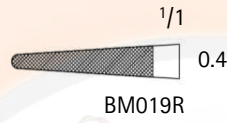

BM019R

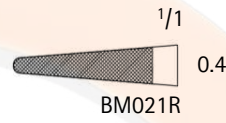

BM021R

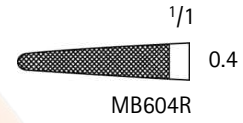

MB604R

DUROGRIP TC CRILE-WOOD Needle Holder

| Catalog Number | Jaw | Length (in.) |
|----------------|--------|--------------|
| BM016R | SERR | 5 3/4 |
| BM017R | SERR | 7 1/4 |
| BM019R | SERR | 7 7/8 |
| BM030R | SERR | 10 5/8 |
| BM021R | SERR | 12 |
| MB604R | SERR | 14 |
| BM029R | SMOOTH | 6 |

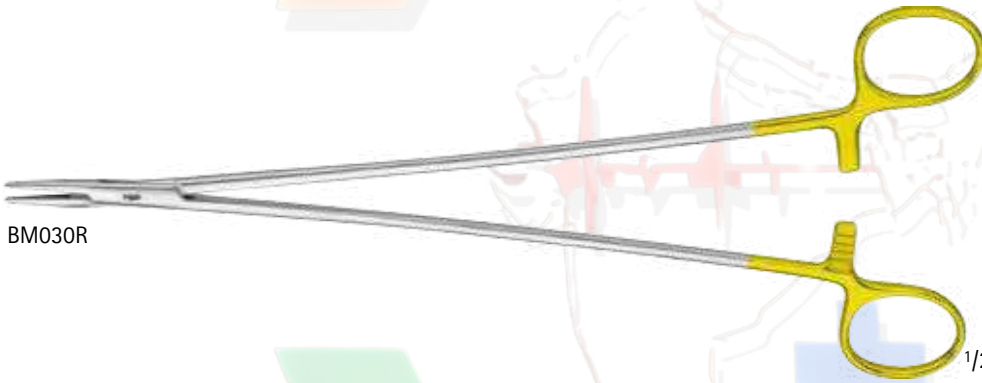

BM030R

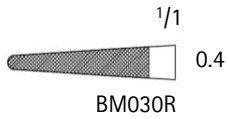

BM030R



BM029R



BM029R





GENERAL SURGERY DUROGRIP™ TC NEEDLE HOLDERS

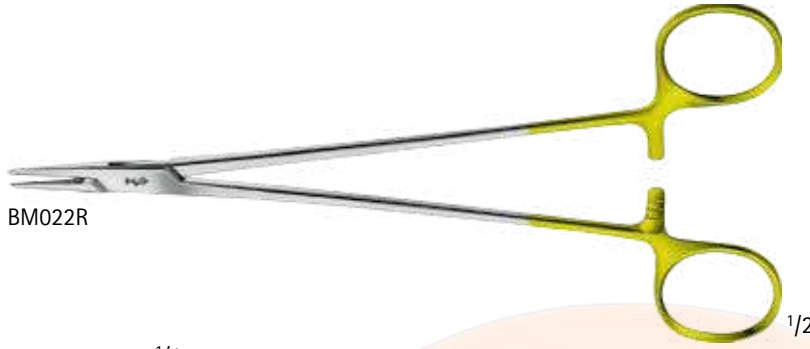

BM022R

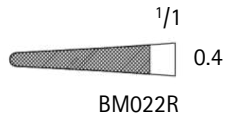

**DUROGRIP TC MAYO-HEGAR-SEELEY
Needle Holder**

| Catalog Number | Jaw | Length (in.) |
|----------------|------|--------------|
| BM022R | SERR | 8 |

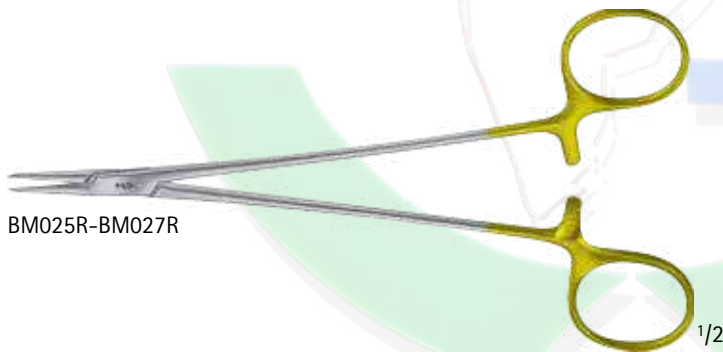

BM025R-BM027R

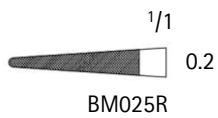

BM025R

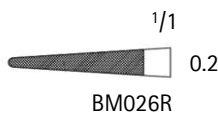

BM026R

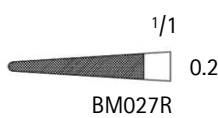

BM027R

DUROGRIP TC Fine Needle Holder

| Catalog Number | Tip | Jaw | Length (in.) |
|----------------|-------|------|--------------|
| BM025R | X-DEL | SERR | 7 |
| BM026R | X-DEL | SERR | 7 7/8 |
| BM027R | X-DEL | SERR | 9 |



GENERAL SURGERY DUROGRIP™ TC NEEDLE HOLDERS

DUROGRIP TC DEBAKEY Needle Holder

| Catalog Number | Tip | Jaw | Length (in.) |
|----------------|-------|------|--------------|
| BM032R | DEL | SERR | 6 |
| BM033R | DEL | SERR | 6 1/2 |
| BM035R | DEL | SERR | 7 |
| BM034R | DEL | SERR | 8 1/4 |
| BM036R | DEL | SERR | 9 |
| BM037R | DEL | SERR | 10 1/4 |
| BM038R | DEL | SERR | 12 |
| BM063R | X-DEL | SERR | 6 1/2 |
| BM064R | X-DEL | SERR | 8 1/4 |
| BM040R | X-DEL | SERR | 12 |

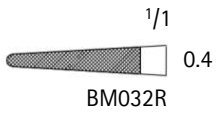

BM032R

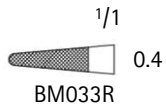
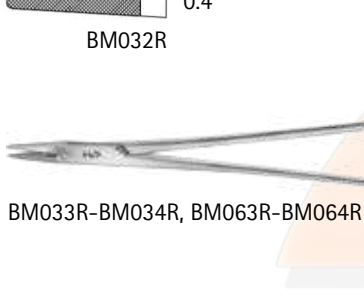

BM033R

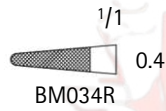

BM034R

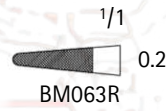

BM063R

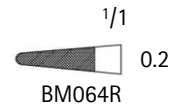

BM064R

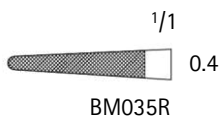
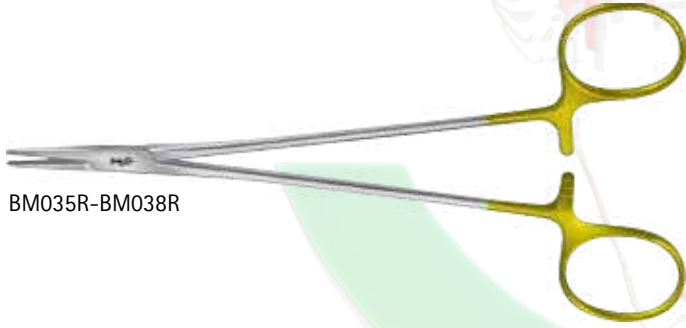

BM035R

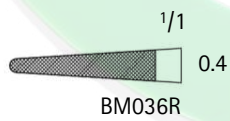

BM036R

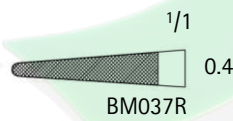

BM037R

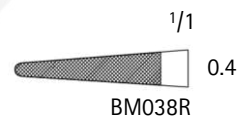

BM038R

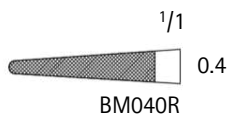

BM040R





GENERAL SURGERY DUROGRIP™ TC NEEDLE HOLDERS

DUROGRIP TC RYDER Needle Holder

| Catalog Number | Tip | Jaw | Length (in.) |
|----------------|-------|--------|--------------|
| BM054R | X-DEL | SERR | 5 1/4 |
| BM055R | X-DEL | SERR | 6 1/8 |
| BM056R | X-DEL | SERR | 6 7/8 |
| BM057R | X-DEL | SERR | 8 1/4 |
| BM058R | X-DEL | SERR | 9 |
| BM044R | DEL | SERR | 5 1/4 |
| BM045R | DEL | SERR | 6 7/8 |
| BM046R | DEL | SERR | 7 3/4 |
| BM047R | DEL | SERR | 10 1/2 |
| BM074R | DEL | SMOOTH | 6 |
| BM075R | DEL | SMOOTH | 7 |
| BM076R | DEL | SMOOTH | 8 7/8 |

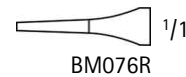
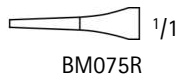
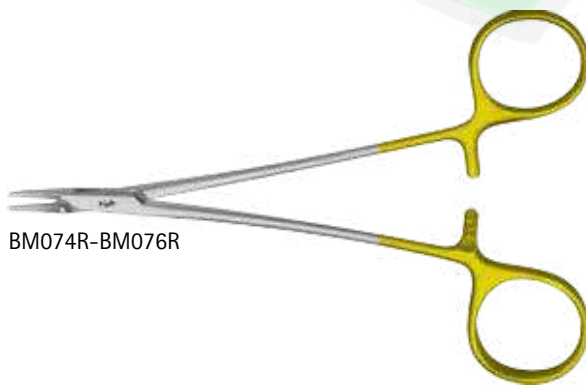
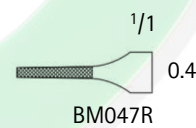
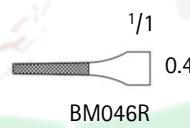
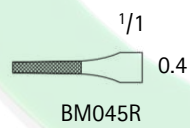
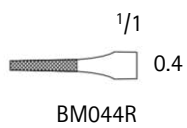
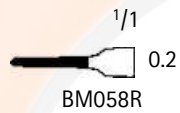
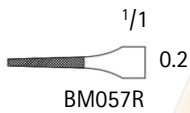
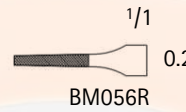
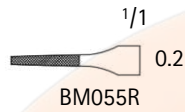
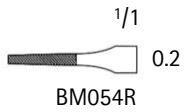
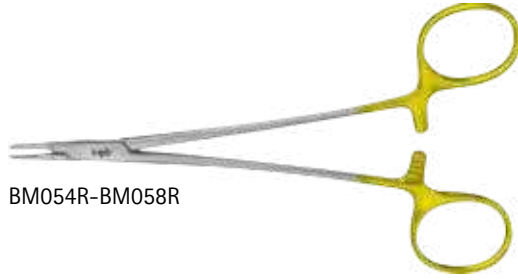



GENERAL SURGERY DUROGRIP™ TC NEEDLE HOLDERS

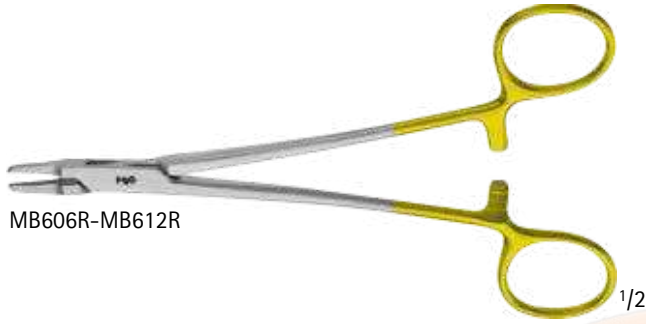

MB606R-MB612R

DUROGRIP TC FRENCH Eye Needle Holder

| Catalog Number | Jaw | Length (in.) |
|----------------|------|--------------|
| MB606R | SERR | 6 1/4 |
| MB607R | SERR | 7 1/4 |
| MB611R | SERR | 8 |
| MB612R | SERR | 9 1/4 |

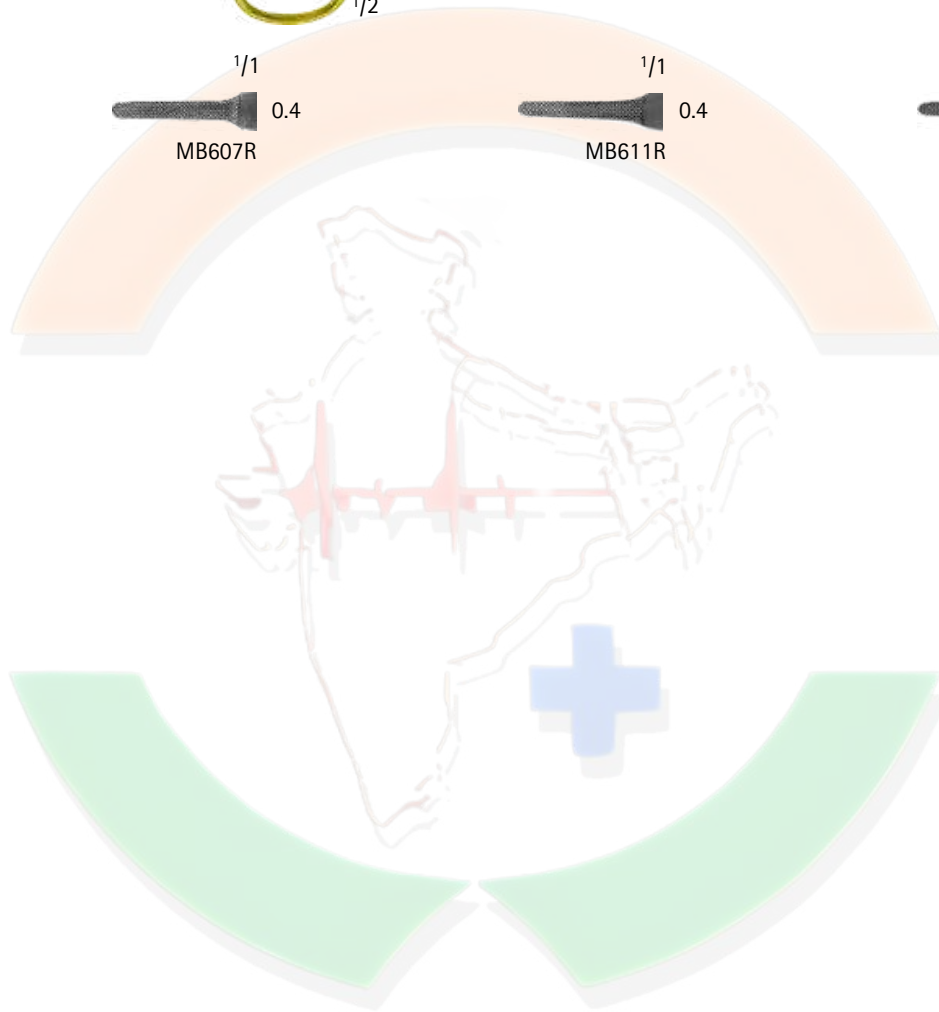
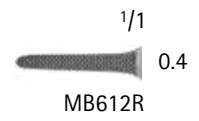
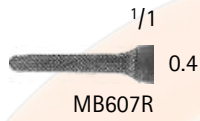
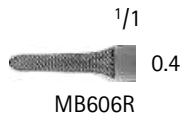



GENERAL SURGERY DUROGRIP™ TC NEEDLE HOLDERS

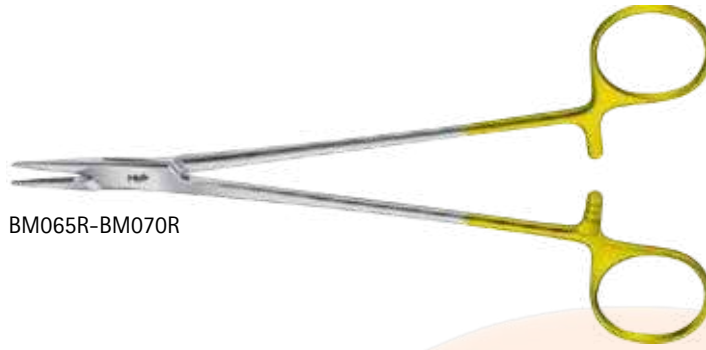

BM065R-BM070R

DUROGRIP TC MAYO-HEGAR Needle Holder

| Catalog Number | Jaw | Length (in.) |
|----------------|------|--------------|
| BM065R | SERR | 6 |
| BM066R | SERR | 7 1/4 |
| BM067R | SERR | 8 |
| BM068R | SERR | 9 1/4 |
| BM070R | SERR | 10 1/2 |
| BM069R | SERR | 12 |
| MB617R | SERR | 14 |

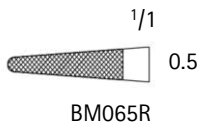

BM065R

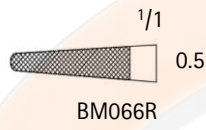

BM066R

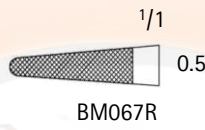

BM067R

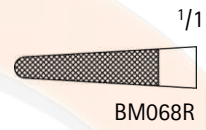

BM068R

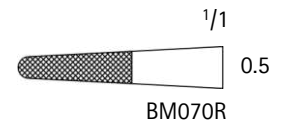

BM070R



BM069R

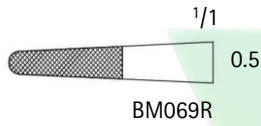

BM069R



MB617R

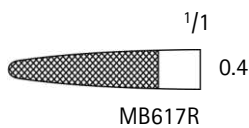

MB617R



GENERAL SURGERY DUROGRIP™ TC NEEDLE HOLDERS

DUROGRIP TC HEGAR Needle Holder

| Catalog Number | Tip | Jaw | Length (in.) |
|----------------|-------|------|--------------|
| BM077R | HEAVY | SERR | 8 |
| BM078R | HEAVY | SERR | 9 1/2 |

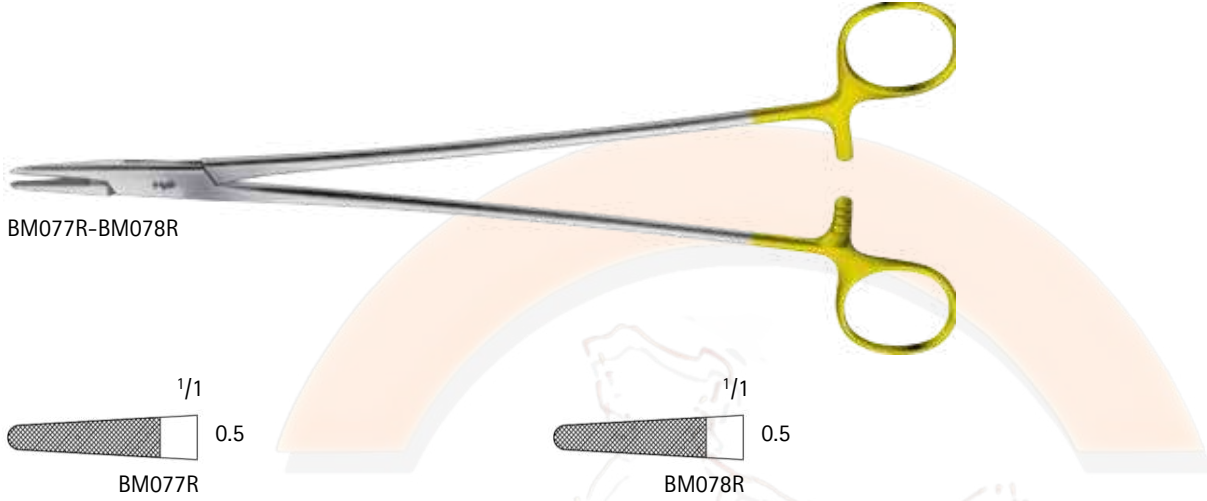

BM077R-BM078R

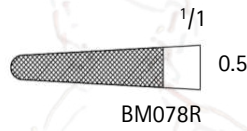
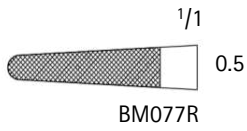

DUROGRIP TC WANGENSTEEN Needle Holder

| Catalog Number | Jaw | Length (in.) |
|----------------|------|--------------|
| BM042R | SERR | 10 3/4 |



BM042R

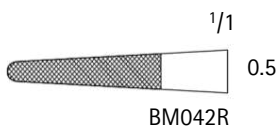



GENERAL SURGERY DUROGRIP™ TC NEEDLE HOLDERS



DUROGRIP TC MASSON Needle Holder

| Catalog Number | Jaw | Length (in.) |
|----------------|------|--------------|
| BM090R | SERR | 10 1/2 |

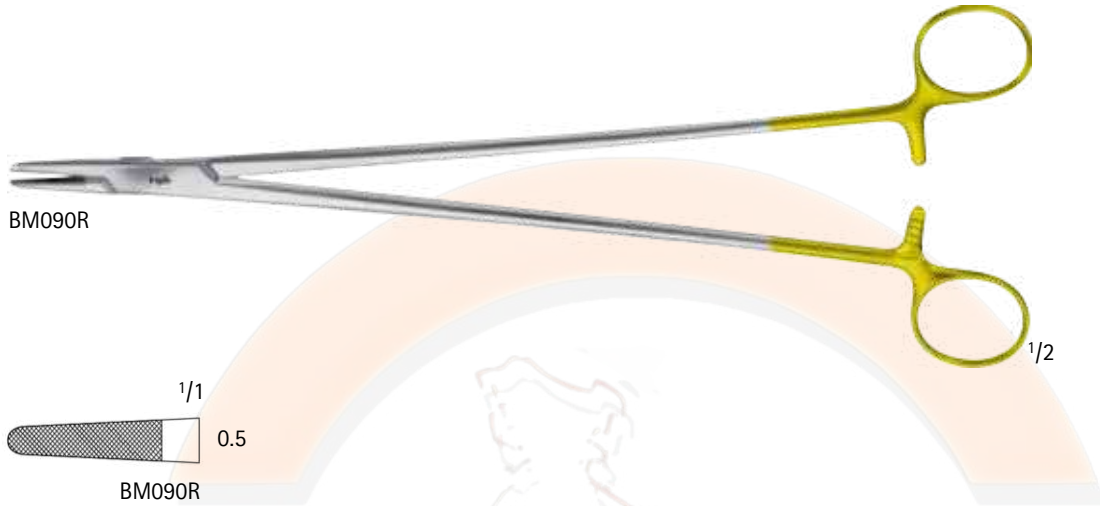

DUROGRIP TC MAYO-MASSON Needle Holder

| Catalog Number | Jaw | Length (in.) |
|----------------|------|--------------|
| MB918R | SERR | 16 |

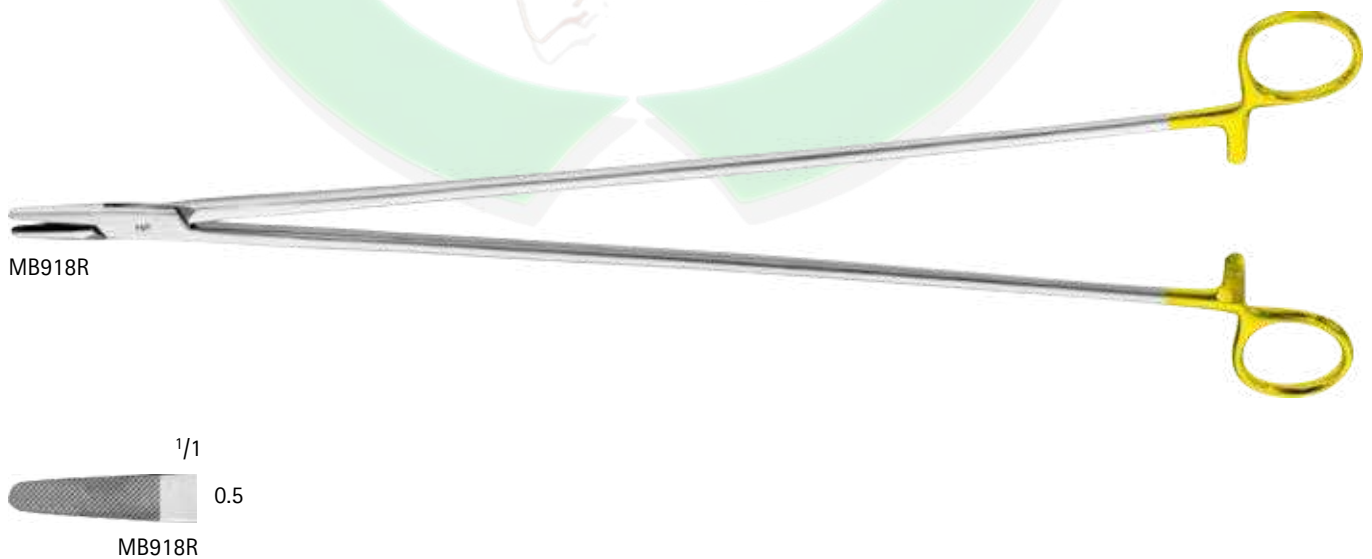



GENERAL SURGERY DUROGRIP™ TC NEEDLE HOLDERS

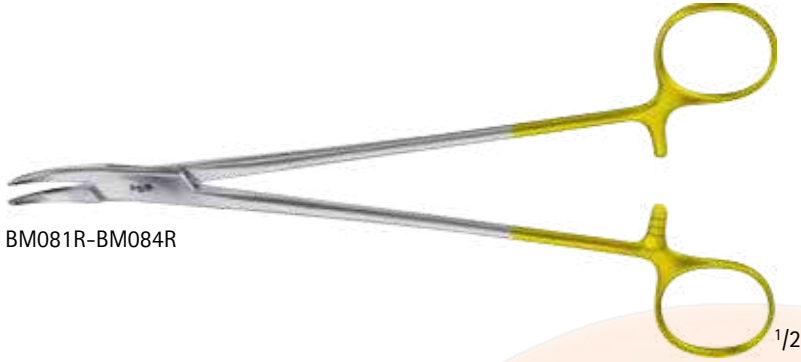

BM081R-BM084R

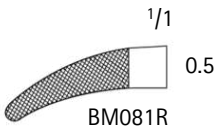

BM081R

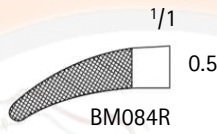

BM084R

DUROGRIP TC HEANEY Needle Holder

| Catalog Number | Tip | Jaw | Length (in.) |
|----------------|-----|------|--------------|
| BM081R | CVD | SERR | 7 7/8 |
| BM084R | CVD | SERR | 10 1/4 |

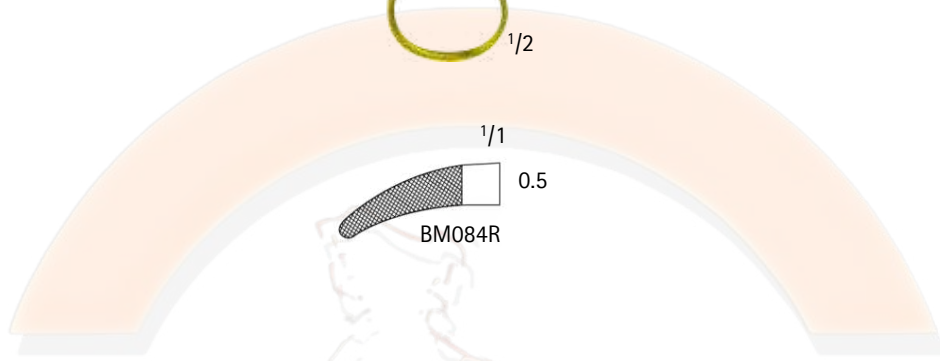

DUROGRIP TC MUELLER Needle Holder

| Catalog Number | Tip | Jaw | Length (in.) |
|----------------|-----|------|--------------|
| BM089R | CVD | SERR | 14 1/4 |



BM089R

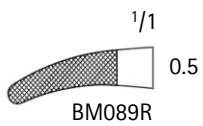

BM089R





GENERAL SURGERY DUROGRIP™ TC NEEDLE HOLDERS

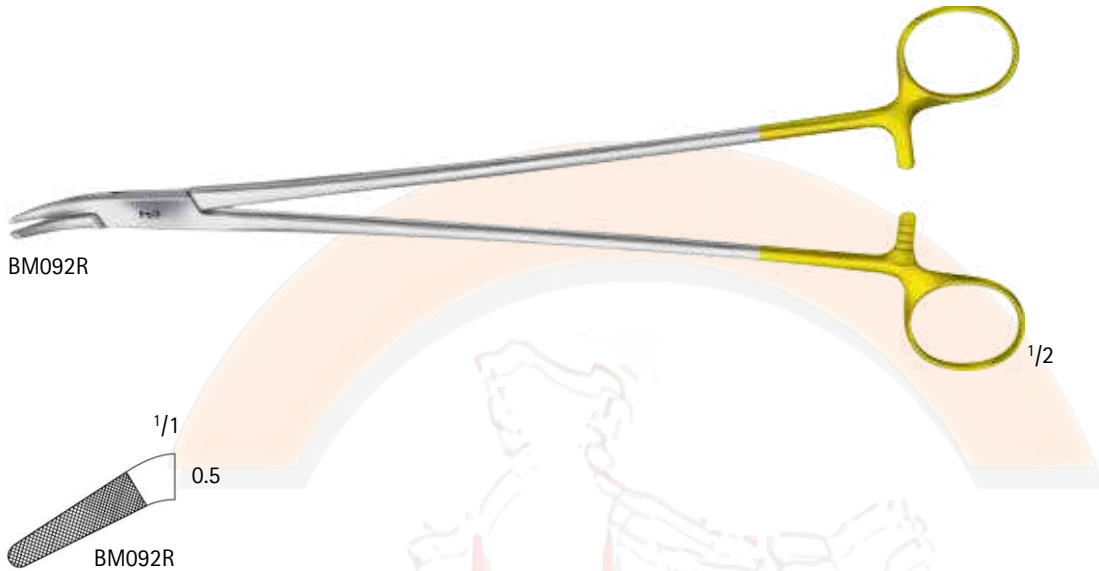

DUROGRIP TC FINOCHIETTO Needle Holder

| Catalog Number | Tip | Jaw | Length (in.) |
|----------------|-----|------|--------------|
| BM092R | ANG | SERR | 10 1/2 |

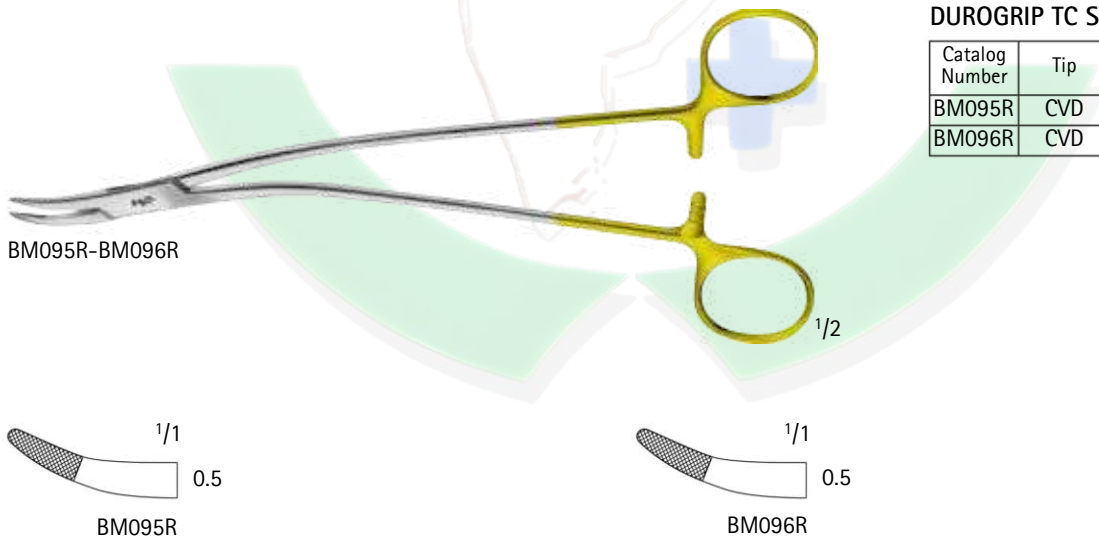

DUROGRIP TC STRATTE Needle Holder

| Catalog Number | Tip | Jaw | Length (in.) |
|----------------|-----|------|--------------|
| BM095R | CVD | SERR | 8 1/4 |
| BM096R | CVD | SERR | 9 |



GENERAL SURGERY DUROGRIP™ TC NEEDLE HOLDERS



BM110R

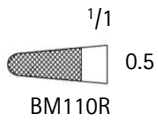

BM110R

DUROGRIP TC Wire Twister

| Catalog Number | Tip | Jaw | Length (in.) |
|----------------|--------|------|--------------|
| BM110R | ROUND | SERR | 6 1/8 |
| BM111R | SQUARE | SERR | 6 |



BM111R

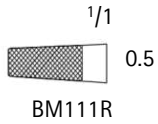

BM111R

DUROGRIP TC BAUMGARTNER Wire Twister

| Catalog Number | Tip | Jaw | Length (in.) |
|----------------|--------|------|--------------|
| BM112R | SQUARE | SERR | 7 7/8 |



BM112R

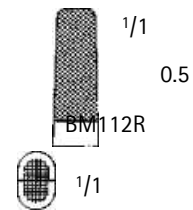

BM112R

1/1





GENERAL SURGERY DUROGRIP™ TC NEEDLE HOLDERS

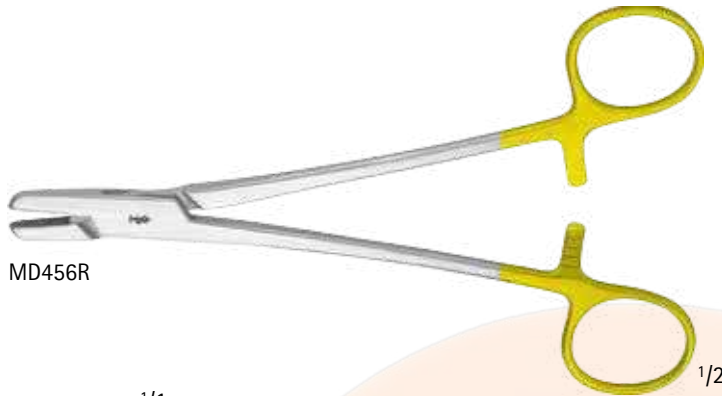

MD456R

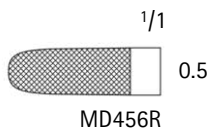

MD456R

DUROGRIP TC BERRY Sternal Wire Twister

| Catalog Number | Tip | Jaw | Length (in.) |
|----------------|-------|------|--------------|
| MD456R | ROUND | SERR | 7 1/4 |

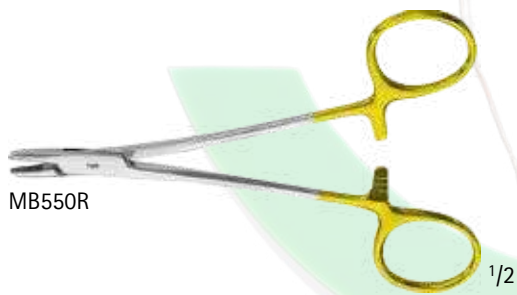

MB550R

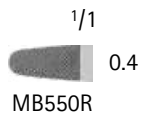

MB550R

DUROGRIP TC RUBIO Wire Twister

| Catalog Number | Tip | Jaw | Length (in.) |
|----------------|-------|------|--------------|
| MB550R | ROUND | SERR | 5 |



GENERAL SURGERY DUROGRIP™ TC NEEDLE HOLDERS



BM149R-BM154R

DUROGRIP TC MATHIEU Needle Holder

| Catalog Number | Jaw | Length (in.) |
|----------------|------|--------------|
| BM149R | SERR | 5 1/2 |
| BM151R | SERR | 6 1/2 |
| BM154R | SERR | 7 7/8 |

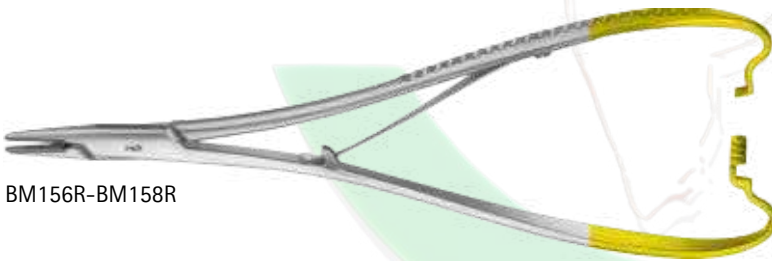
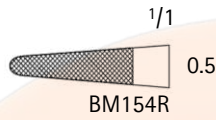
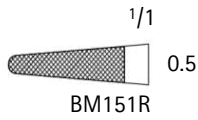
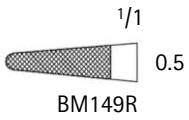

BM156R-BM158R

DUROGRIP TC MATHIEU Needle Holder, Heavy

| Catalog Number | Jaw | Length (in.) |
|----------------|------|--------------|
| BM156R | SERR | 7 7/8 |
| BM158R | SERR | 9 5/8 |

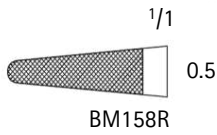
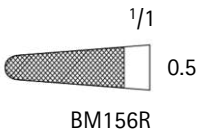



GENERAL SURGERY NEEDLE CASES



BL907R

Needle Case, Rectangle

| Catalog Number | Dimensions (mm) |
|----------------|-----------------|
| BL907R | 70 x 53 x 9 |



BL930R-BL933R

Needle Case, Round

| Catalog Number | Item | Dimensions (mm) |
|----------------|--------------------------------------|-----------------|
| BL930R | COMPLETE NEEDLE CASE W/ INTERIOR BOX | 65 x 16 |
| BL931R | INTERIOR BOX ONLY | 62 x 12 |
| BL933R | INTERIOR BOX ONLY | 90 x 12 |



BL931R-BL933R

Needle Case, With 7 Sections

| Catalog Number | Dimensions (mm) |
|----------------|-----------------|
| BL941R | 150 x 90 x 10 |



BL941R

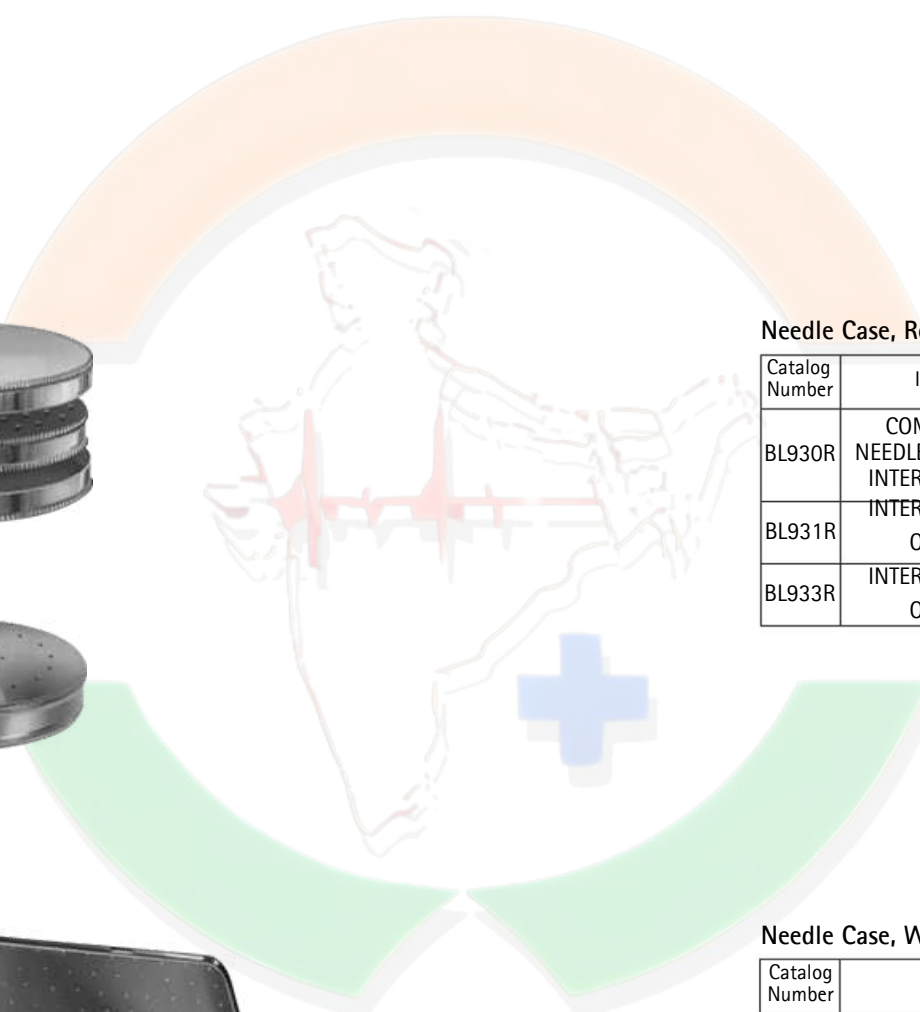



GENERAL SURGERY LIGATURE NEEDLES



BM822R-BM824R

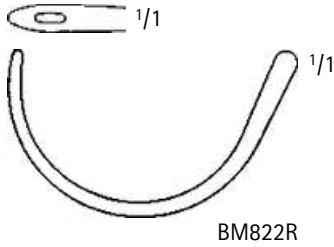

BM822R

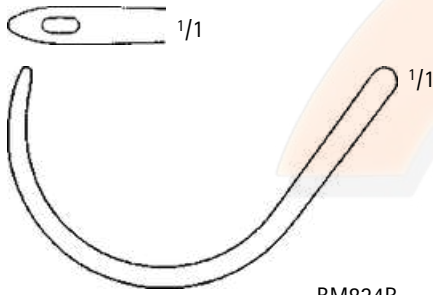

BM824R



BM749R, BM781R, BM807R, BM809R,
BM811R, BM813R

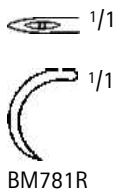

BM781R

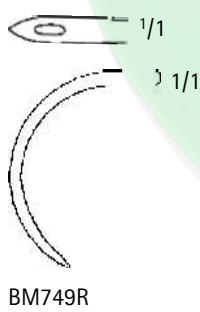

BM749R



BM809R



BM807R

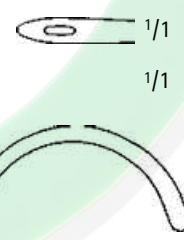

BM811R

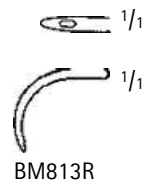

BM813R

DESCHAMPS Needle

| Catalog Number | Hand Orientation | Tip | Length (in.) |
|----------------|------------------|--------------------|--------------|
| BM822R | RIGHT | BLUNT, 3.5 MM | 9 1/2 |
| BM824R | RIGHT | BLUNT, 5 MM | 11 |
| BM781R | LEFT | SHARP, 2 MM | 8 1/4 |
| BM749R | LEFT | SHARP, 3.5 MM | 8 1/2 |
| BM809R | LEFT | BLUNT, 2.5 MM | 8 1/4 |
| BM807R | LEFT | BLUNT, 2.5 MM | 8 1/2 |
| BM811R | LEFT | BLUNT, 3.5 MM | 8 1/2 |
| BM813R | LEFT | STEEP, BLUNT, 2 MM | 8 7/8 |





GENERAL SURGERY LIGATURE NEEDLES



BM770R

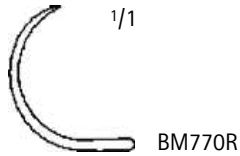
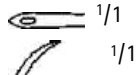

BM771R

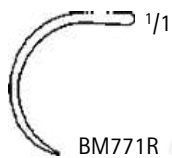
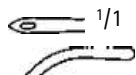

BM801R

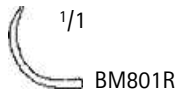
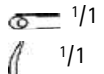

BM802R

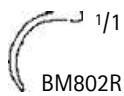
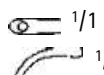

BM855R



HURD Needle

| Catalog Number | Hand Orientation | Tip | Length (in.) |
|----------------|------------------|-------|--------------|
| BM770R | RIGHT | SHARP | 8 1/4 |
| BM771R | LEFT | SHARP | 8 1/4 |

KRONECKER Needle

| Catalog Number | Hand Orientation | Tip | Length (in.) |
|----------------|------------------|-------|--------------|
| BM801R | RIGHT | BLUNT | 6 1/8 |
| BM802R | LEFT | BLUNT | 6 1/8 |

SYME Suture Needle

| Catalog Number | Tip | Length (in.) |
|----------------|-------|--------------|
| BM855R | BLUNT | 6 3/4 |



GENERAL SURGERY DRESSING AND TISSUE FORCEPS

Monopolar Diathermi Forceps, Insulated

| Catalog Number | Length (in.) |
|----------------|--------------|
| GK033R | 13 3/4 |

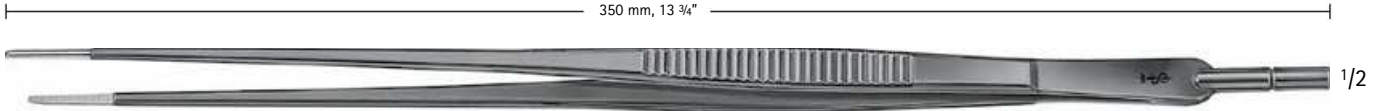

GK033R



GK033R



BD043R-BD053R

Dressing Forceps, Standard Patterns

| Catalog Number | Tip | Length (in.) |
|----------------|------|--------------|
| BD043R | SERR | 4 1/2 |
| BD045R | SERR | 5 1/8 |
| BD047R | SERR | 5 3/4 |
| BD049R | SERR | 6 1/4 |
| BD050R | SERR | 7 |
| BD051R | SERR | 7 7/8 |
| BD052R | SERR | 9 3/4 |
| BD053R | SERR | 11 3/4 |



BD043R

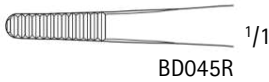

BD045R

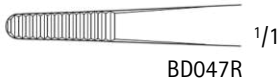

BD047R

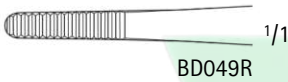

BD049R

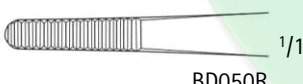

BD050R

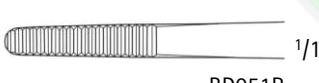

BD051R

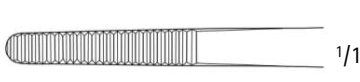

BD052R



BD053R



BD077R



BD077R

Dressing Forceps, Extra Wide

| Catalog Number | Tip | Length (in.) |
|----------------|------|--------------|
| BD077R | SERR | 5 3/4 |

GENERAL SURGERY





GENERAL SURGERY DRESSING AND TISSUE FORCEPS



BD023R-BD033R



BD023R

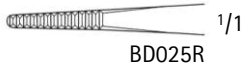

BD025R



BD027R



BD029R

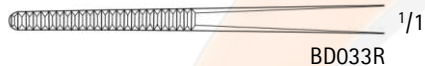

BD033R



BD035R-BD037R

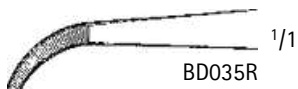

BD035R



BD037R



BD210R

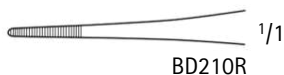

BD210R

Dressing Forceps, Delicate

| Catalog Number | Tip | Length (in.) |
|----------------|-----------|--------------|
| BD023R | STR, SERR | 4 1/2 |
| BD025R | STR, SERR | 5 1/8 |
| BD027R | STR, SERR | 5 3/4 |
| BD029R | STR, SERR | 6 1/4 |
| BD033R | STR, SERR | 12 |
| BD035R | CVD, SERR | 5 1/8 |
| BD037R | CVD, SERR | 5 1/2 |

Dressing Forceps, Extra Delicate

| Catalog Number | Tip | Length (in.) |
|----------------|------|--------------|
| BD210R | SERR | 4 1/2 |

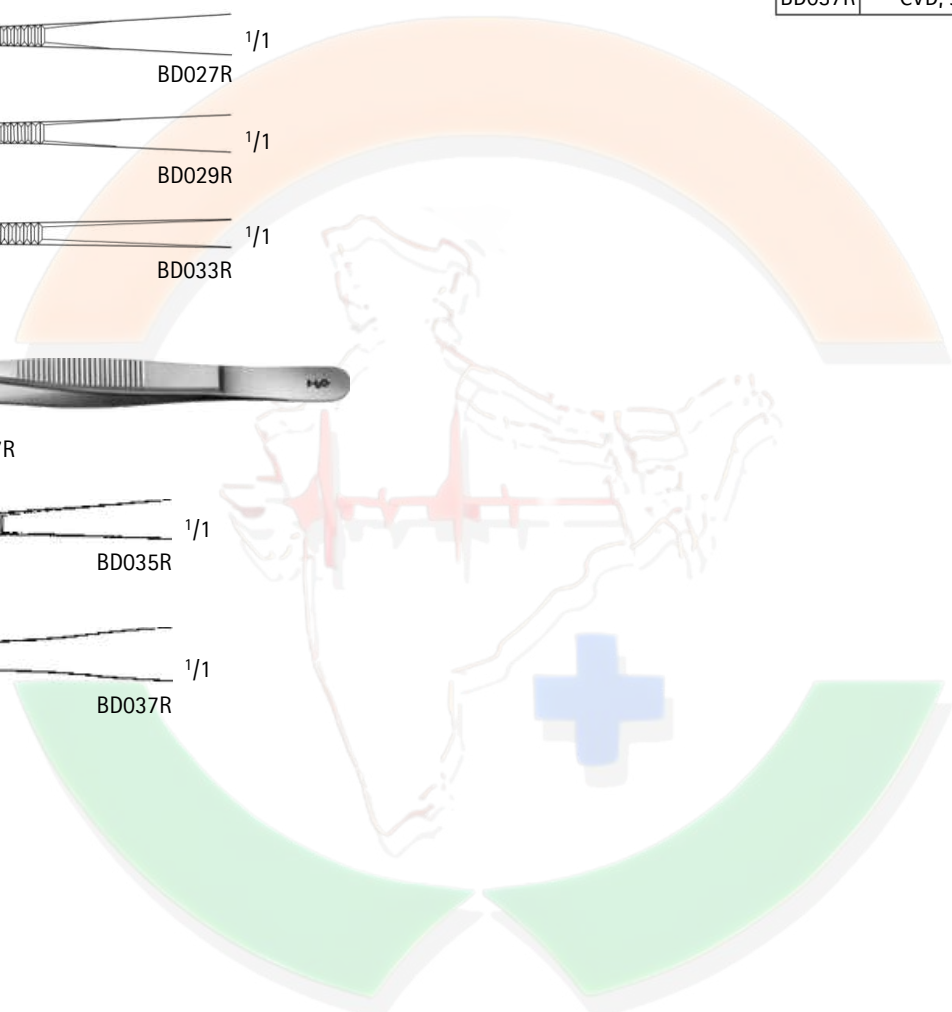



GENERAL SURGERY DRESSING AND TISSUE FORCEPS

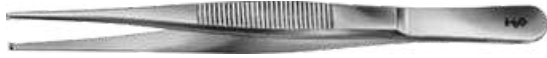

BD533R-BD543R

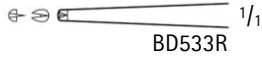

BD533R 1/1



BD535R 1/1



BD537R 1/1

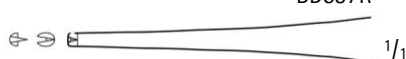

BD539R 1/1



BD540R 1/1



BD541R 1/1



BD542R 1/1



BD543R 1/1



MB803R

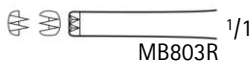

MB803R 1/1



BD575R-BD581R



BD575R 1/1



BD577R 1/1

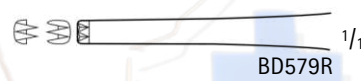

BD579R 1/1



BD580R 1/1

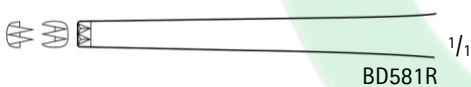

BD581R 1/1

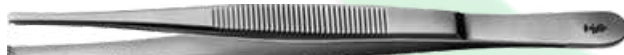

BD587R-BD591R

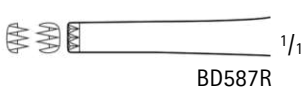

BD587R 1/1



BD589R 1/1

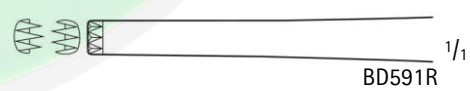

BD591R 1/1



BD527R



BD527R 1/1



BD547R-BD549R



BD547R 1/1

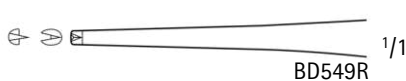

BD549R 1/1

Tissue Forceps, Delicate

| Catalog Number | Tip | Teeth | Length (in.) |
|----------------|-----|-------|--------------|
| BD533R | STR | 1 x 2 | 4 1/2 |
| BD535R | STR | 1 x 2 | 5 1/8 |
| BD537R | STR | 1 x 2 | 5 3/4 |
| BD539R | STR | 1 x 2 | 6 1/4 |
| BD540R | STR | 1 x 2 | 7 |
| BD541R | STR | 1 x 2 | 7 7/8 |
| BD542R | STR | 1 x 2 | 9 3/4 |
| BD543R | STR | 1 x 2 | 11 3/4 |
| MB803R | STR | 2 x 3 | 4 1/2 |
| BD575R | STR | 2 x 3 | 5 1/8 |
| BD577R | STR | 2 x 3 | 5 3/4 |
| BD579R | STR | 2 x 3 | 6 1/4 |
| BD580R | STR | 2 x 3 | 7 |
| BD581R | STR | 2 x 3 | 7 7/8 |
| BD587R | STR | 3 x 4 | 5 3/4 |
| BD589R | STR | 3 x 4 | 6 1/4 |
| BD591R | STR | 3 x 4 | 7 7/8 |
| BD527R | CVD | 1 x 2 | 5 3/4 |

Tissue Forceps, Medium

| Catalog Number | Teeth | Length (in.) |
|----------------|-------|--------------|
| BD547R | 1 x 2 | 5 3/4 |
| BD549R | 1 x 2 | 6 1/4 |





GENERAL SURGERY DRESSING AND TISSUE FORCEPS

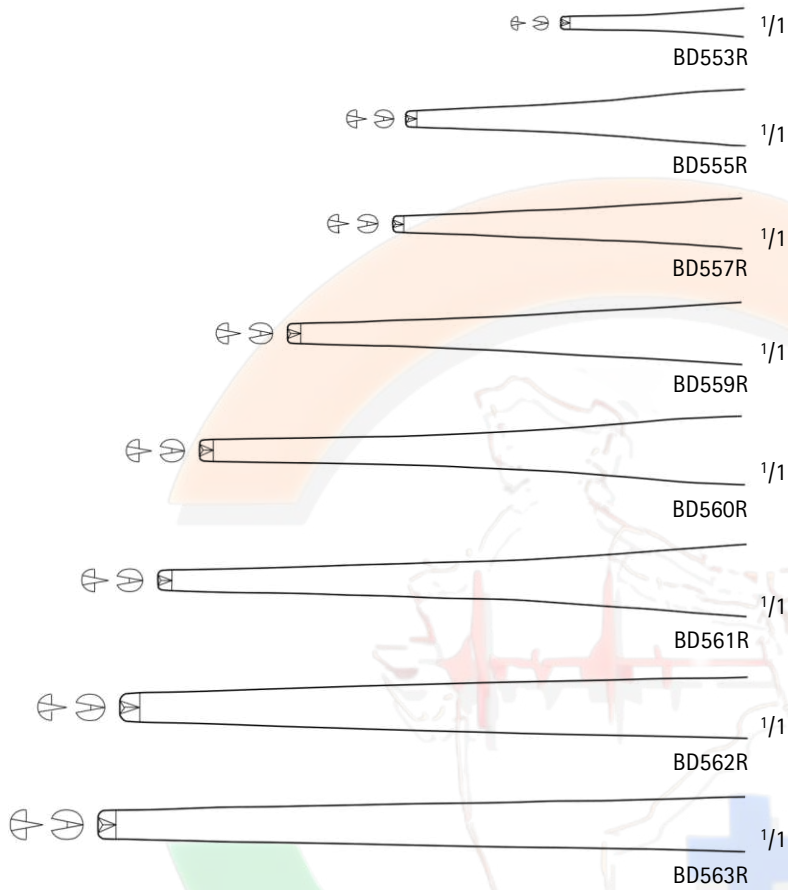

Tissue Forceps, Standard Patterns

| Catalog Number | Teeth | Length (in.) |
|----------------|-------|--------------|
| BD553R | 1 x 2 | 4 1/2 |
| BD555R | 1 x 2 | 5 1/8 |
| BD557R | 1 x 2 | 5 3/4 |
| BD559R | 1 x 2 | 6 1/4 |
| BD560R | 1 x 2 | 7 |
| BD561R | 1 x 2 | 7 7/8 |
| BD562R | 1 x 2 | 9 3/4 |
| BD563R | 1 x 2 | 11 3/4 |

GENERAL SURGERY DRESSING AND TISSUE FORCEPS



BD690R-BD692R

STRASSBURGER Tissue Forceps

| Catalog Number | Tip | Teeth | Length (in.) |
|----------------|--------|-------|--------------|
| BD690R | X-SERR | 1 x 2 | 6 |
| BD692R | X-SERR | 1 x 2 | 7 7/8 |



BD690R



BD692R

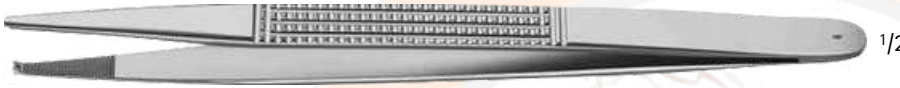

MG077R

CURTIS Tissue Forceps

| Catalog Number | Tip | Length (in.) |
|----------------|------|--------------|
| MG077R | SERR | 8 3/4 |



MG077R



BD693R

BONNEY Tissue Forceps

| Catalog Number | Tip | Teeth | Length (in.) |
|----------------|------|-------|--------------|
| BD693R | SERR | 1 x 2 | 6 7/8 |
| MG357R | SERR | 2 x 3 | 6 3/4 |



BD693R



MG357R



MG357R



BD733R

MARTIN Tissue Forceps

| Catalog Number | Teeth | Length (in.) |
|----------------|-------|--------------|
| BD733R | 7 x 8 | 6 1/8 |

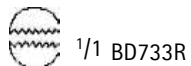

BD733R





GENERAL SURGERY DRESSING AND TISSUE FORCEPS



MB224



MB224



MG464R-MG465R



MG464R



MG465R



BD725R-BD727R



BD725R



BD726R



BD727R



BD755R



BD755R



BD760R-BD761R, MB921R-MB922R, XG006R

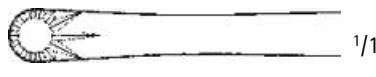

BD760R



BD761R, MB921R, MB922R

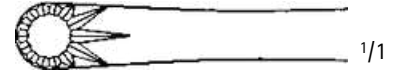

XG006R

HEANEY Tissue Forceps

| Catalog Number | Tip | Teeth | Length (in.) |
|----------------|--------|-------|--------------|
| MG464R | X-SERR | 1 x 2 | 7 1/4 |
| MB224 | X-SERR | 2 x 3 | 5 1/2 |
| MG465R | X-SERR | 3 x 4 | 7 1/2 |

STILLE-BARRAYA CV Forceps

| Catalog Number | Tip | Teeth | Length (in.) |
|----------------|--------|-------|--------------|
| BD725R | X-SERR | 3 x 4 | 7 |
| BD726R | X-SERR | 3 x 4 | 7 7/8 |
| BD727R | X-SERR | 3 x 4 | 9 3/4 |

RUSSIAN Tissue Forceps

| Catalog Number | Length (in.) |
|----------------|--------------|
| BD755R | 6 |
| BD760R | 7 7/8 |
| XG006R | 9 3/4 |
| BD761R | 10 1/4 |
| MB921R | 12 |
| MB922R | 14 |



GENERAL SURGERY DRESSING AND TISSUE FORCEPS



MB208R-MB923R



MAYO-RUSSIAN Tissue Forceps

| Catalog Number | Tip | Length (in.) |
|----------------|-------------|--------------|
| MB208R | FENESTRATED | 9 |
| MB923R | FENESTRATED | 14 |



BD750R



MB795R

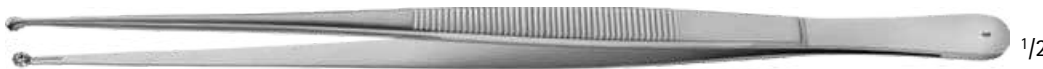

MG078R



SELMAN Tissue Forceps

| Catalog Number | Length (in.) |
|----------------|--------------|
| BD750R | 6 1/8 |
| MB795R | 7 7/8 |
| MG078R | 9 3/4 |





GENERAL SURGERY DRESSING AND TISSUE FORCEPS

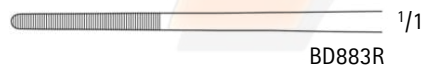
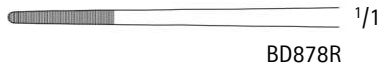

LUCAE Bayonet Forceps

| Catalog Number | Tip | Teeth | Length (in.) |
|----------------|--------|-------|--------------|
| BD878R | SERR | - | 5 1/2 |
| BD879R | SMOOTH | 1 x 2 | 5 1/2 |

GRUENWALD Bayonet Forceps

| Catalog Number | Tip | Length (in.) |
|----------------|------|--------------|
| BD883R | SERR | 7 7/8 |

CUSHING Bayonet Forceps

| Catalog Number | Tip | Teeth | Length (in.) |
|----------------|--------|-------|--------------|
| US147 | SERR | - | 7 3/4 |
| MB231 | SMOOTH | 1 x 2 | 7 1/4 |

BROWN-CUSHING Bayonet Forceps

| Catalog Number | Teeth | Length (in.) |
|----------------|-------|--------------|
| MB227 | 7 x 7 | 7 1/4 |



GENERAL SURGERY DRESSING AND TISSUE FORCEPS



BD876R, MB804R



BD876R, MB804R

BROWN-BAHNSON Bayonet Forceps

| Catalog Number | Tip | Length (in.) |
|----------------|------|--------------|
| BD876R | SERR | 6 1/8 |
| MB804R | SERR | 8 |



BD880R, MB236



BD880R



MB236

JANSEN Bayonet Forceps

| Catalog Number | Tip | Length (in.) |
|----------------|------|--------------|
| BD880R | SERR | 6 1/4 |
| MB236 | SERR | 6 1/2 |



BD885R

1/2

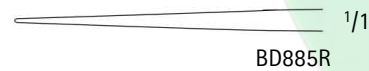

BD885R



BD886R

1/2



BD886R

Bayonet Forceps

| Catalog Number | Tip | Teeth | Length (in.) |
|----------------|--------|-------|--------------|
| BD885R | SMOOTH | - | 7 1/4 |
| BD886R | SMOOTH | 1 x 2 | 7 7/8 |



US104-US105

1/2



US105



US104

GERALD Bayonet Forceps

| Catalog Number | Tip | Teeth | Length (in.) |
|----------------|--------|-------|--------------|
| US105 | SERR | - | 7 1/2 |
| US104 | SMOOTH | 1 x 2 | 7 1/2 |

GENERAL SURGERY





GENERAL SURGERY DRESSING AND TISSUE FORCEPS

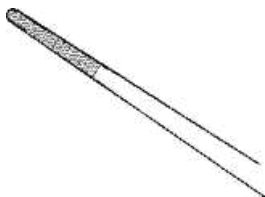
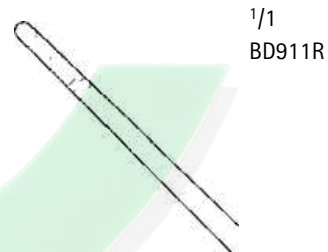
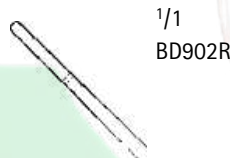
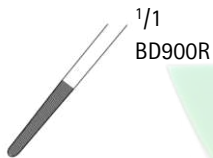

Bayonet Forceps

| Catalog Number | Tip | Length (in.) |
|----------------|-------|--------------|
| BD887R | | 6 1/4 |
| FD110R | FINE | 7 1/4 |
| FD111R | BROAD | 7 1/4 |

TROELTSCH Bayonet Forceps

| Catalog Number | Tip | Length (in.) |
|----------------|----------|--------------|
| BD900R | ANG/SERR | 4 |
| BD902R | ANG/SERR | 4 1/2 |
| BD910R | ANG/SERR | 5 1/2 |
| BD911R | ANG/SERR | 6 3/4 |

WILDE Bayonet Forceps

| Catalog Number | Tip | Length (in.) |
|----------------|----------|--------------|
| BD904R | ANG/SERR | 4 1/2 |



GENERAL SURGERY DRESSING AND TISSUE FORCEPS



BD225R, MB291R



BD225R

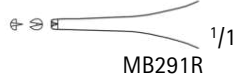

MB291R

HUDSON Forceps

| Catalog Number | Tip | Teeth | Length (in.) |
|----------------|--------|-------|--------------|
| BD225R | SERR | - | 5 |
| MB291R | SMOOTH | 1 x 2 | 5 |



BD610R-BD611R



BD610R



BD611R

FERRIS-SMITH Tissue Forceps

| Catalog Number | Tip | Teeth | Length (in.) |
|----------------|--------|-------|--------------|
| BD610 | X-SERR | 1 x 2 | 6 7/8 |
| R | X-SERR | 2 x 3 | 6 7/8 |

BD611
R

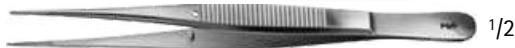

BD215R-BD216R

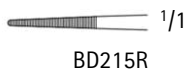

BD215R

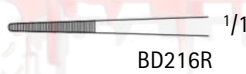

BD216R

SEMKEN Forceps, Delicate

| Catalog Number | Tip | Teeth | Length (in.) |
|----------------|--------|-------|--------------|
| BD215R | SERR | - | 5 |
| BD216R | SERR | - | 6 |
| BD665R | SMOOTH | 1 x 2 | 5 |
| BD667R | SMOOTH | 1 x 2 | 6 |
| BD666R | SMOOTH | 2 x 3 | 5 |



BD665R-BD667R



BD665R



BD667R

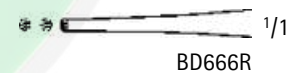

BD666R

Micro ADSON Forceps, Delicate

| Catalog Number | Tip | Length (in.) |
|----------------|-------------------|--------------|
| BD220R | SERR, W/ PLATFORM | 4 3/4 |
| BD223R | SERR | 6 |



BD220R

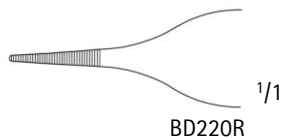

BD220R



BD223R

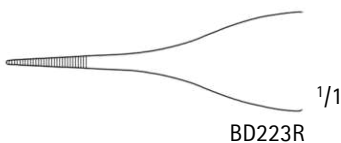

BD223R





GENERAL SURGERY DRESSING AND TISSUE FORCEPS



BD222R, MA156R

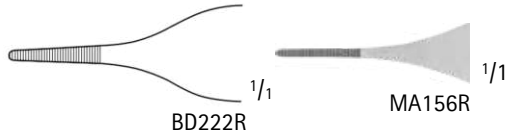

BD511R



MG275R



BD512R



MA536R



MB454R



BD506R



BD507R



BD508R



BD513R



BD521R

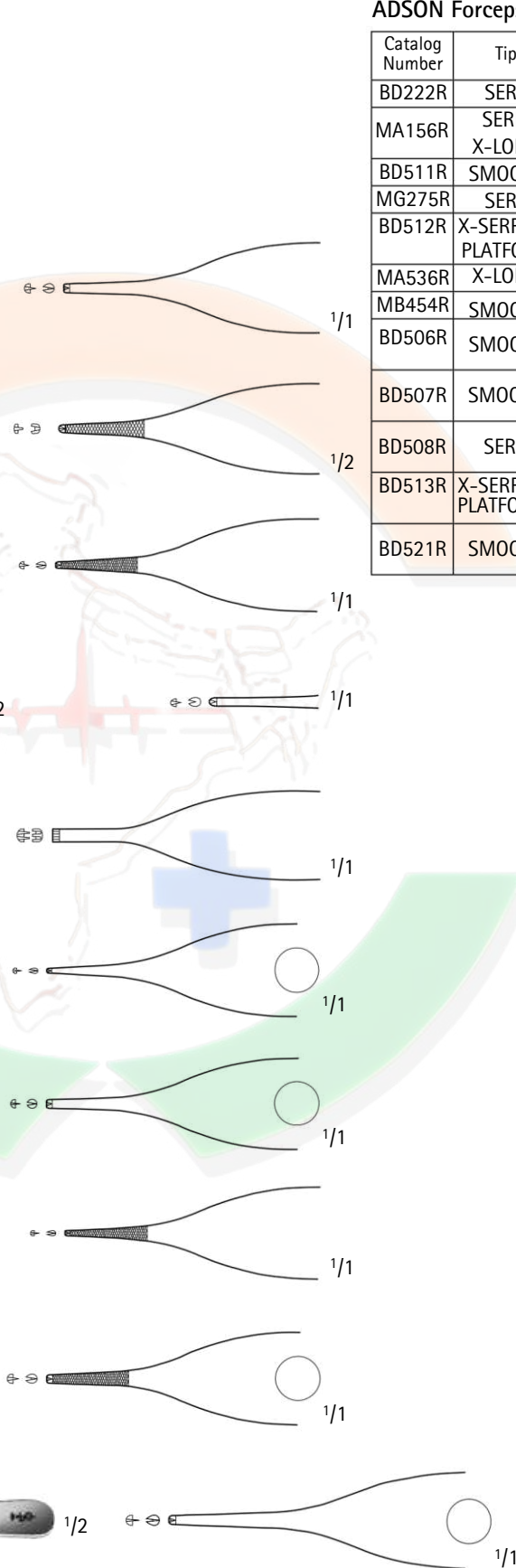

ADSON Forceps, Delicate

| Catalog Number | Tip | Teeth | Handle | Length (in.) |
|----------------|--------------------|-------|--------------|--------------|
| BD222R | SERR | - | - | 4 3/4 |
| MA156R | SERR, X-LONG | 1 x 2 | - | 4 3/4 |
| BD511R | SMOOTH | 1 x 2 | - | 4 3/4 |
| MG275R | SERR | 1 x 2 | - | 4 3/4 |
| BD512R | X-SERR W/ PLATFORM | 1 x 2 | - | 4 3/4 |
| MA536R | X-LONG | 1 x 2 | - | 4 3/4 |
| MB454R | SMOOTH | 2 x 3 | - | 4 3/4 |
| BD506R | SMOOTH | 1 x 2 | FENE-STRATED | 4 3/4 |
| BD507R | SMOOTH | 1 x 2 | FENE-STRATED | 4 3/4 |
| BD508R | SERR | 1 x 2 | FENE-STRATED | 4 3/4 |
| BD513R | X-SERR W/ PLATFORM | 1 x 2 | FENE-STRATED | 4 3/4 |
| BD521R | SMOOTH | 1 x 2 | FENE-STRATED | 6 |



GENERAL SURGERY DRESSING AND TISSUE FORCEPS

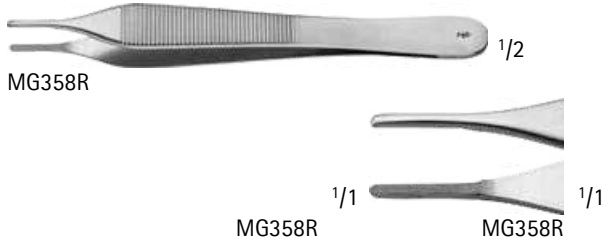

MUSTARDE Suture Removal Forceps

| Catalog Number | Tip | Length (in.) |
|----------------|--------------------|--------------|
| MG358R | LONGITUDINAL, SERR | 5 |

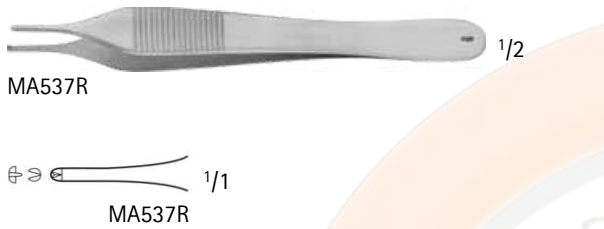

CALLISON-ADSON Tissue Forceps, W/ Platform

| Catalog Number | Teeth | Length (in.) |
|----------------|-------|--------------|
| MA537R | 1 x 2 | 5 |

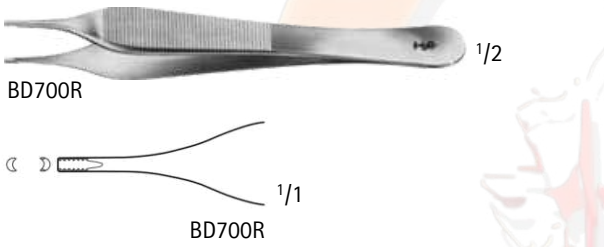

ADSON-BROWN Tissue Forceps

| Catalog Number | Teeth | Length (in.) |
|----------------|-------|--------------|
| BD700R | 7 x 8 | 4 3/4 |

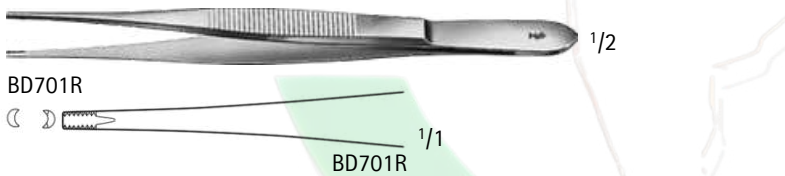

BROWN Tissue Forceps

| Catalog Number | Teeth | Length (in.) |
|----------------|-------|--------------|
| BD701R | 7 x 8 | 6 |
| BD702R | 7 x 8 | 7 7/8 |

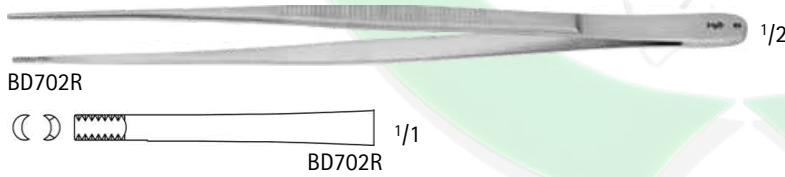

MICRO ADSON Tissue Forceps, Delicate

| Catalog Number | Teeth | Length (in.) |
|----------------|-------|--------------|
| BD510R | 1 x 2 | 4 3/4 |
| BD520R | 1 x 2 | 6 |

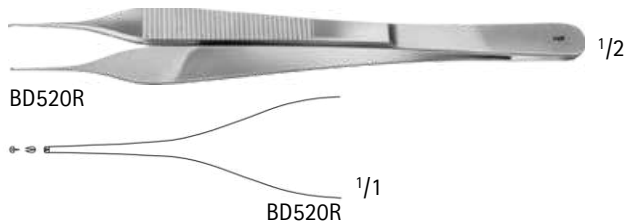
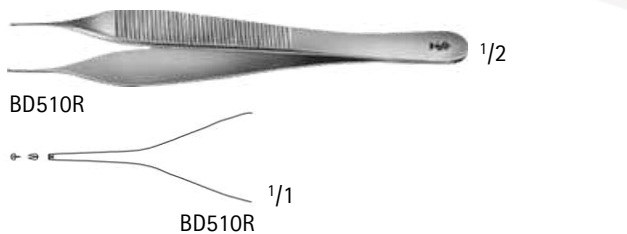



GENERAL SURGERY DRESSING AND TISSUE FORCEPS



BD662R-BD664R



BD662R

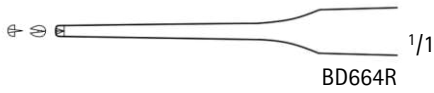

BD664R



BD663R

GERALD Tissue Forceps, Delicate

| Catalog Number | Tip | Teeth | Length (in.) |
|----------------|-----|-------|--------------|
| BD662R | STR | 1 x 2 | 6 7/8 |
| BD664R | STR | 1 x 2 | 9 |
| BD663R | CVD | 1 x 2 | 6 7/8 |



MG422R

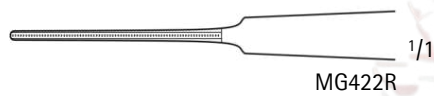

MG422R

GERALD-DEBAKEY Forceps, Narrow

| Catalog Number | Tip | Length (in.) |
|----------------|------|--------------|
| MG422R | SERR | 9 |



BD522R

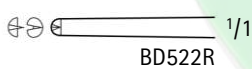

BD522R

ADSON Tissue Forceps, Delicate

| Catalog Number | Teeth | Length (in.) |
|----------------|-------|--------------|
| BD522R | 1 x 2 | 7 |



BD523R

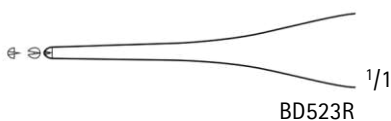

BD523R

JEFFERSON Tissue Forceps, Delicate

| Catalog Number | Teeth | Length (in.) |
|----------------|-------|--------------|
| BD523R | 1 x 2 | 7 |



GENERAL SURGERY DRESSING AND TISSUE FORCEPS



BD228R-BD230R

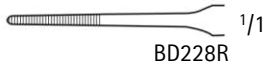

BD228R

1/1

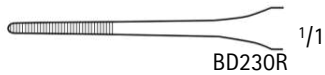

BD230R

1/1

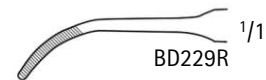

BD229R

1/1



BD236R

1/2



BD236R

1/1



BD661R

1/2

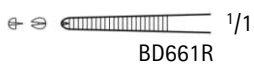

BD661R

1/1



BD257R

1/2

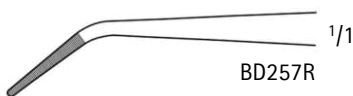

BD257R

1/1

GERALD Dressing Forceps, Delicate

| Catalog Number | Tip | Length (in.) |
|----------------|-----------|--------------|
| BD228R | STR, SERR | 6 7/8 |
| BD230R | STR, SERR | 9 |
| BD229R | CVD, SERR | 6 7/8 |

MCINDOE Thumb Forceps, Delicate

| Catalog Number | Tip | Length (in.) |
|----------------|------|--------------|
| BD236R | SERR | 6 |

MCINDOE Tissue Forceps, Delicate

| Catalog Number | Tip | Teeth | Length (in.) |
|----------------|------|-------|--------------|
| BD661R | SERR | 1 x 2 | 6 |

Delicate Forceps, Angled

| Catalog Number | Tip | Length (in.) |
|----------------|------|--------------|
| BD257R | SERR | 7 7/8 |





GENERAL SURGERY DRESSING AND TISSUE FORCEPS



BD238R-BD243R



BD238R



BD239R



BD240R



BD243R



MD463



MD463



BD246R



BD246R

CUSHING Forceps, Delicate

| Catalog Number | Tip | Length (in.) |
|----------------|-----------|--------------|
| BD238R | STR, SERR | 7 |
| BD239R | STR, SERR | 7 7/8 |
| BD240R | STR, SERR | 9 3/4 |
| BD243R | CVD, SERR | 7 7/8 |

CUSHING Tissue Forceps

| Catalog Number | Teeth | Length (in.) |
|----------------|-------|--------------|
| MD463 | 1 x 2 | 7 |

BROPHY Forceps, Delicate

| Catalog Number | Tip | Length (in.) |
|----------------|------|--------------|
| BD246R | SERR | 7 7/8 |



GENERAL SURGERY DRESSING AND TISSUE FORCEPS



BD231R-BD232R



BD231R

1/1



BD232R

1/1

Forceps, Delicate

| Catalog Number | Tip | Length (in.) |
|----------------|--------|--------------|
| BD231R | SMOOTH | 7 |
| BD232R | SMOOTH | 7 7/8 |



BD301R-BD305R



BD301R

1/1



BD302R

1/1

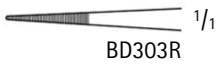

BD303R

1/1

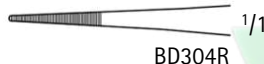

BD304R

1/1



BD305R

1/1

Micro Dressing Forceps

| Catalog Number | Tip | Length (in.) |
|----------------|-----------|--------------|
| BD301R | STR, SERR | 3 1/2 |
| BD302R | STR, SERR | 4 1/8 |
| BD303R | STR, SERR | 4 1/2 |
| BD304R | STR, SERR | 5 1/8 |
| BD305R | STR, SERR | 5 3/4 |
| BD311R | CVD, SERR | 3 1/2 |
| BD312R | CVD, SERR | 4 1/8 |
| BD313R | CVD, SERR | 4 1/2 |
| BD314R | CVD, SERR | 5 1/8 |
| BD315R | CVD, SERR | 5 3/4 |



BD311R-BD315R



BD311R

1/1



BD312R

1/1



BD313R

1/1



BD314R

1/1



BD315R

1/1





GENERAL SURGERY DRESSING AND TISSUE FORCEPS



BD500R



BD500R



BD501R

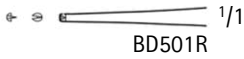

BD501R



BD502R



BD502R



BD335R



BD335R



BD330R



BD330R



BD331R

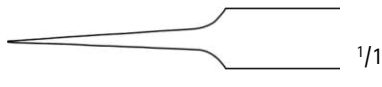

BD331R



BD333R

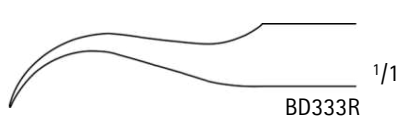

BD333R

Micro Tissue Forceps

| Catalog Number | Teeth | Length (in.) |
|----------------|-------|--------------|
| BD500R | 1 x 2 | 4 |
| BD501R | 1 x 2 | 4 1/4 |
| BD502R | 2 x 3 | 4 1/4 |

Micro Forceps #3 Jewelers

| Catalog Number | Tip Size (mm) | Length (in.) |
|----------------|---------------|--------------|
| BD335R | 0.3 | 5 1/4 |

Micro Forceps #4 Jewelers

| Catalog Number | Tip Size (mm) | Length (in.) |
|----------------|---------------|--------------|
| BD330R | 0.2 | 4 1/4 |

Micro Forceps #5 Jewelers

| Catalog Number | Tip Size (mm) | Length (in.) |
|----------------|---------------|--------------|
| BD331R | 0.15 | 4 1/4 |

Micro Forceps #7 Jewelers

| Catalog Number | Tip Size (mm) | Length (in.) |
|----------------|---------------|--------------|
| BD333R | 0.2 | 4 1/2 |



GENERAL SURGERY DRESSING AND TISSUE FORCEPS



GILLIES Tissue Forceps, Delicate

| Catalog Number | Tip | Teeth | Length (in.) |
|----------------|--------|-------|--------------|
| BD660R | X-SERR | 1 x 2 | 6 1/8 |



SEMKEN Tissue Forceps, Delicate

| Catalog Number | Teeth | Length (in.) |
|----------------|-------|--------------|
| BD669R | 1 x 2 | 5 3/4 |

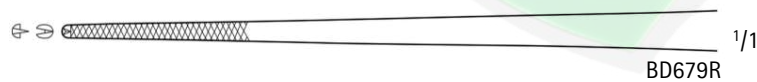
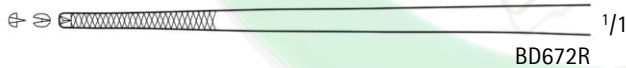

WAUGH Tissue Forceps, Delicate

| Catalog Number | Tip | Teeth | Length (in.) |
|----------------|--------|-------|--------------|
| BD670R | X-SERR | 1 x 2 | 7 |
| BD671R | X-SERR | 1 x 2 | 7 7/8 |
| BD672R | X-SERR | 1 x 2 | 9 3/4 |
| BD679R | X-SERR | 1 x 2 | 12 |



DOCKTOR Forceps

| Catalog Number | Tip | Teeth | Length (in.) |
|----------------|--------|-------|--------------|
| MB211R | X-SERR | 1 x 2 | 4 3/4 |





GENERAL SURGERY DRESSING AND TISSUE FORCEPS



FC411R

1/2



1/1
FC411R



FC412R

1/2

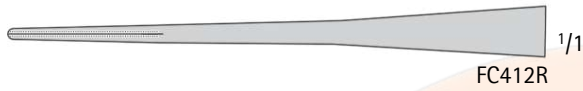

1/1
FC412R



FC413R

1/2



1/1
FC413R



FC418R

1/2



1/1
FC418R



FB394R-FB396R

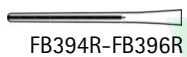

FB394R-FB396R



FB411R-FB419R

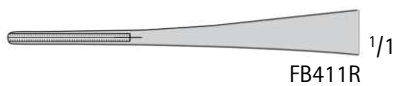

1/1
FB411R



1/1
FB412R



1/1
FB418R



1/1
FB419R

DEBAKEY Atraumatic Ultra Light Forceps

| Catalog Number | Tip Size (mm) | Length (in.) |
|----------------|---------------|--------------|
| FC411R | 1.2 | 6 |
| FC412R | 1.5 | 7 7/8 |
| FC413R | 1.5 | 9 1/2 |
| FC418R | 1.5 | 11 3/4 |

DEBAKEY Atraumatic Vascular Tissue Forceps

| Catalog Number | Tip Size (mm) | Length (in.) |
|----------------|---------------|--------------|
| FB394R | 1 | 6 |
| FB395R | 1 | 7 3/4 |
| FB396R | 1 | 9 1/2 |

DEBAKEY Atraumatic Forceps

| Catalog Number | Tip Size (mm) | Length (in.) |
|----------------|---------------|--------------|
| FB411R | 1.5 | 6 |
| FB412R | 1.5 | 7 7/8 |
| FB418R | 1.5 | 9 1/2 |
| FB419R | 1.5 | 11 3/4 |

GENERAL SURGERY DRESSING AND TISSUE FORCEPS

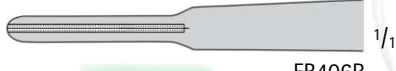
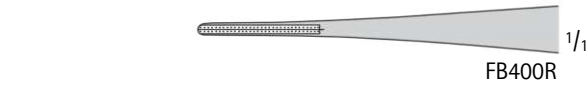

DEBAKEY Atraumatic Forceps

| Catalog Number | Tip Size (mm) | Length (in.) |
|----------------|---------------|--------------|
| FB400R | 2 | 6 |
| FB402R | 2 | 7 7/8 |
| FB404R | 2 | 9 1/2 |
| FB405R | 2 | 11 3/4 |
| FB414R | 2.8 | 6 |
| FB415R | 2.8 | 7 7/8 |
| FB416R | 2.8 | 9 1/2 |
| FB417R | 2.8 | 11 3/4 |
| FB406R | 3.5 | 7 7/8 |
| FB407R | 3.5 | 9 1/2 |
| FB408R | 3.5 | 11 3/4 |
| FB409R | 3.5 | 13 3/4 |





GENERAL SURGERY DRESSING AND TISSUE FORCEPS

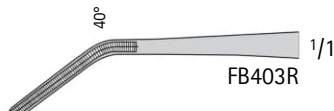
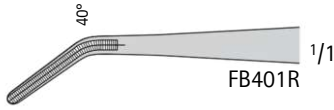

DEBAKEY Atraumatic Forceps, Angled

| Catalog Number | Tip Size (mm) | Length (in.) |
|----------------|---------------|--------------|
| FB401R | 2 | 6 |
| FB403R | 2 | 7 7/8 |
| FB410R | 2 | 9 1/2 |



COOLEY Atraumatic Vascular Tissue Forceps

| Catalog Number | Tip Size (mm) | Length (in.) |
|----------------|---------------|--------------|
| FB784R | 1.5 | 6 |
| FB785R | 2.0 | 7 3/4 |
| FB786R | 2.3 | 9 1/2 |



COOLEY Vascular Tissue Forceps

| Catalog Number | Length (in.) |
|----------------|--------------|
| BD250R | 7 7/8 |



GENERAL SURGERY DRESSING AND TISSUE FORCEPS



BD770R

1/2



BD770R

1/1

MILLS Mammary/Coronary Tissue Forceps

| Catalog Number | Length (in.) |
|----------------|--------------|
| BD770R | 7 |



FB130R

1/2

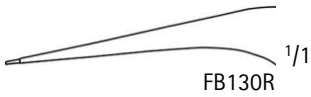

FB130R

1/1

Dilator Forceps

| Catalog Number | Tip Size (mm) | Length (in.) |
|----------------|---------------|--------------|
| FB130R | 0.2 | 4 1/2 |



BD980R

1/2



BD980R

1/1

HUNTER Splinter Forceps

| Catalog Number | Length (in.) |
|----------------|--------------|
| BD980R | 4 1/8 |





GENERAL SURGERY DUROGRIP™ TC TISSUE FORCEPS

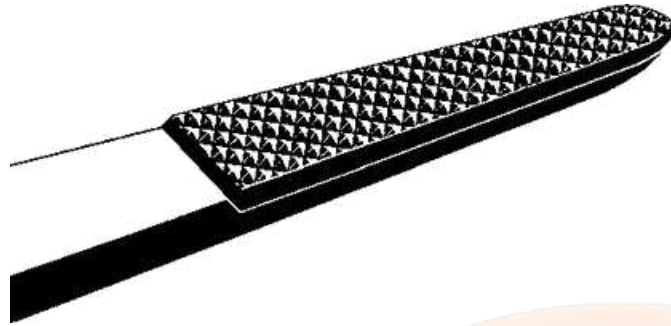

DUROGRIP Tungsten Carbide Tissue Forceps

- Cross-Serrated Platform tips for firm and non-traumatic grip
- Long working life
- Gold-plated end



BD151R

1/2

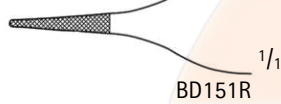

1/1
BD151R



US109-US110

1/2

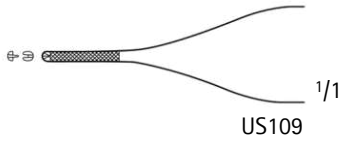

1/1
US109



1/1
US110



MB484R-MB485R

1/2



1/1
MB484R



1/1
MB485R



US112

1/2

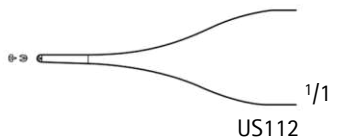

1/1
US112

DUROGRIP TC ADSON Forceps

| Catalog Number | Tip | Teeth | Length (in.) |
|----------------|-------------|-------|--------------|
| BD151R | X-SERR | - | 4 3/4 |
| US109 | X-SERR | 1 x 2 | 4 3/4 |
| US110 | DEL, X-SERR | 1 x 2 | 4 3/4 |
| MB484R | X-SERR | 1 x 2 | 6 |
| MB485R | DEL, X-SERR | 1 x 2 | 6 |

DUROGRIP TC GORNEY-ADSON Forceps

| Catalog Number | Tip | Teeth | Length (in.) |
|----------------|-------------|-------|--------------|
| US112 | DEL, SMOOTH | 1 x 2 | 4 3/4 |



GENERAL SURGERY DUROGRIP™ TC TISSUE FORCEPS

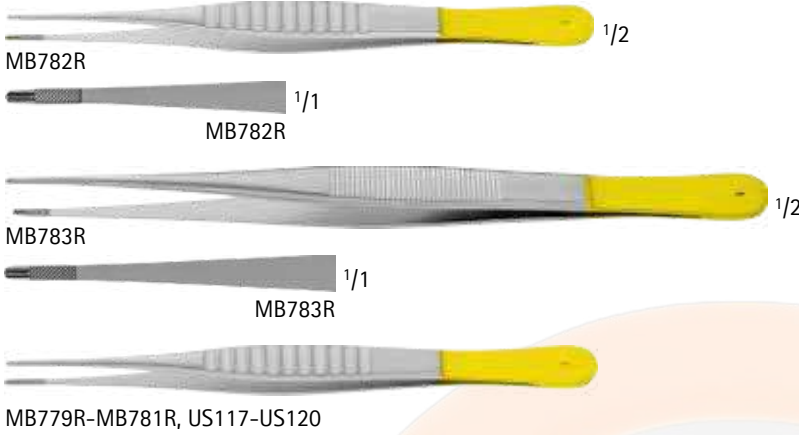

DUROGRIP TC DEBAKEY Needle Forceps

| Catalog Number | Tip | Tip Size (mm) | Length (in.) |
|----------------|--------|---------------|--------------|
| MB782R | - | 1.5 | 6 |
| MB783R | - | 1.5 | 7 3/4 |
| US119 | NARROW | 1.5 | 7 3/4 |
| MB779R | - | 2 | 6 |
| MB780R | - | 2 | 8 |
| MB781R | - | 2 | 10 1/2 |
| US117 | - | 2 | 6 |
| US118 | - | 2 | 8 |
| US120 | NARROW | 2 | 9 |

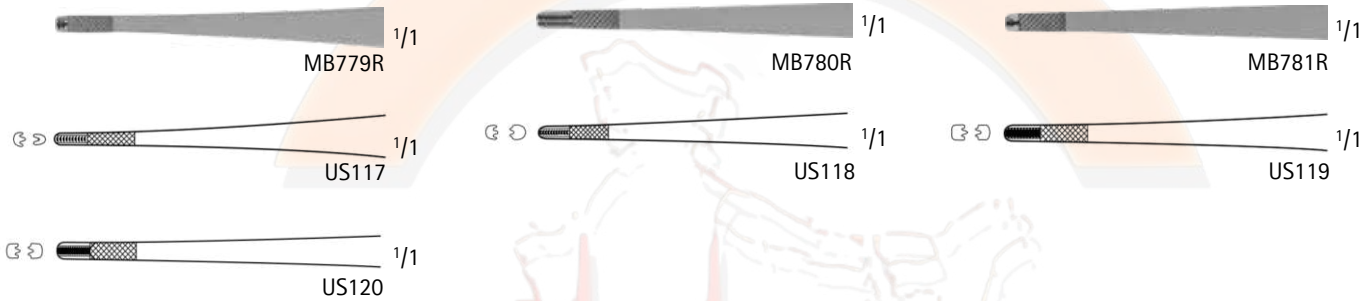

GERALD Needle Forceps

| Catalog Number | Tip | Teeth | Length (in.) |
|----------------|--------|-------|--------------|
| MG356R | X-SERR | 1 x 2 | 6 7/8 |

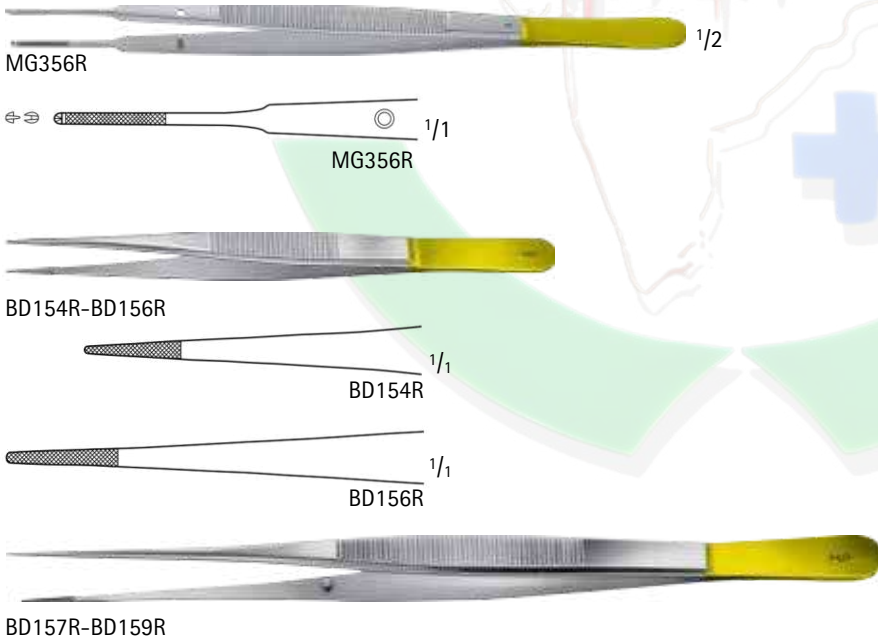

DUROGRIP TC (POTTS-SMITH) Thumb Forceps

| Catalog Number | Tip Number | Length (in.) |
|----------------|------------|--------------|
| BD154R | X-SERR | 5 3/4 |
| BD156R | X-SERR | 7 |
| BD157R | X-SERR | 7 7/8 |
| BD158R | X-SERR | 9 |
| BD159R | X-SERR | 9 3/4 |

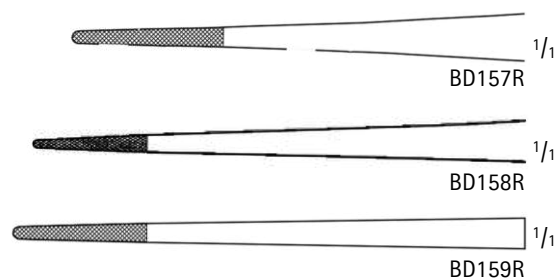



GENERAL SURGERY DUROGRIP™ TC TISSUE FORCEPS



BD160R-BD198R

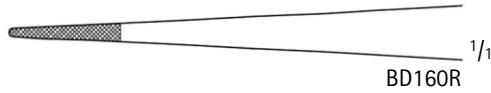

BD160R



BD198R

**DUROGRIP TC CUSHING Forceps,
W/ Scraper End**

| Catalog Number | Tip | Length (in.) |
|----------------|--------|--------------|
| BD160R | X-SERR | 7 |
| BD198R | X-SERR | 9 3/4 |



MB308R



MB308R

DUROGRIP TC CUSHING Forceps

| Catalog Number | Tip | Length (in.) |
|----------------|-------------|--------------|
| MB308R | ANG, X-SERR | 6 1/4 |



US111



US111

DUROGRIP TC SEMKEN Forceps

| Catalog Number | Tip | Tip Size (mm) | Teeth | Length (in.) |
|----------------|--------|---------------|-------|--------------|
| US111 | X-SERR | 1 | 1 x 2 | 6 1/4 |



GENERAL SURGERY DUROGRIP™ TC TISSUE FORCEPS



BD164R-BD166R

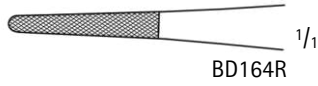

BD164R

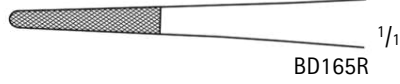

BD165R

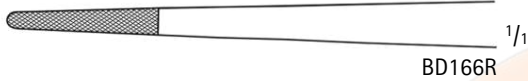

BD166R

DUROGRIP TC STANDARD Forceps

| Catalog Number | Tip | Length (in.) |
|----------------|--------|--------------|
| BD164R | X-SERR | 5 3/4 |
| BD165R | X-SERR | 7 7/8 |
| BD166R | X-SERR | 9 3/4 |



BD168R

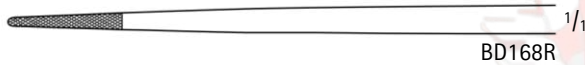

BD168R

DUROGRIP TC GRUENWALD Forceps

| Catalog Number | Tip | Length (in.) |
|----------------|--------|--------------|
| BD168R | X-SERR | 7 1/4 |



BD171R-BD173R

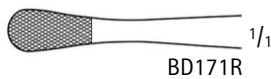

BD171R



BD173R

DUROGRIP TC WANGENSTEEN Forceps

| Catalog Number | Tip | Length (in.) |
|----------------|--------|--------------|
| BD171R | X-SERR | 6 |
| BD173R | X-SERR | 9 |





AMRAMED[®]
TECH Pvt. Ltd.

Wholesale Supplier

A to Z Hospital Equipment and
Surgical Products B to C



Certified Register

GENERAL SURGERY ABDOMINAL AND INTESTINAL GRASPING FORCEPS

LAHEY Forceps

| Catalog Number | Teeth | Length (in.) |
|----------------|-------|--------------|
| BF309R | 2 x 2 | 6 1/8 |
| BF310R | 3 x 3 | 6 1/8 |
| MG360R | 3 x 3 | 8 |
| BF311R | 4 x 4 | 6 1/8 |

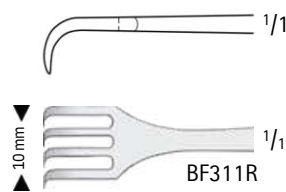
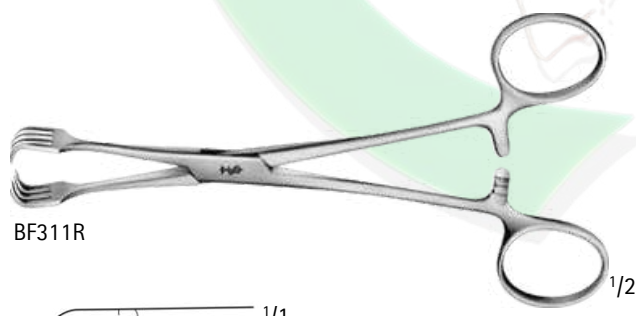
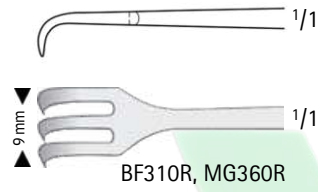
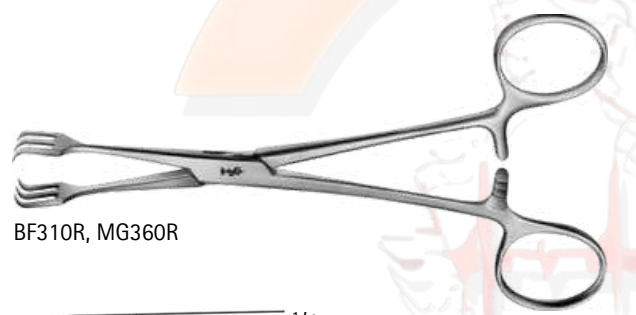
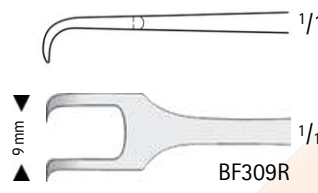
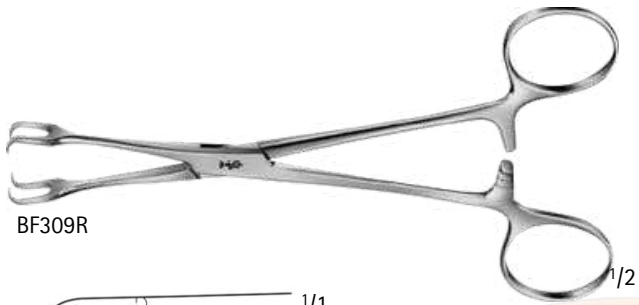

GENERAL SURGERY ABDOMINAL AND INTESTINAL GRASPING FORCEPS



EA010R



EA010R

BOYS-ALLIS Forceps

| Catalog Number | Teeth | Length (in.) |
|----------------|-------|--------------|
| EA010R | 5 x 6 | 6 1/8 |

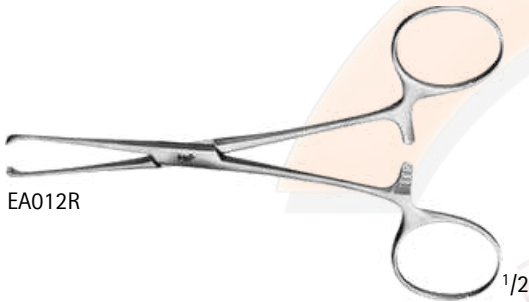

EA012R



EA012R

Baby ALLIS Forceps

| Catalog Number | Teeth | Length (in.) |
|----------------|-------|--------------|
| EA012R | 4 x 5 | 5 1/8 |

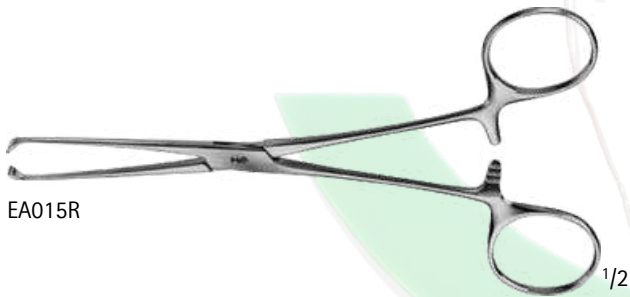

EA015R



EA015R

ALLIS Forceps

| Catalog Number | Teeth | Length (in.) |
|----------------|-------|--------------|
| EA015R | 4 x 5 | 6 1/8 |
| EA016R | 5 x 6 | 6 1/8 |
| EA017R | 5 x 6 | 7 1/2 |
| FB938R | 5 x 6 | 8 3/4 |
| EA018R | 5 x 6 | 10 |
| MB910R | 5 x 6 | 16 |



EA016R-MB910R



EA016R-MB910R

GENERAL SURGERY





GENERAL SURGERY ABDOMINAL AND INTESTINAL GRASPING FORCEPS



MG235R



MG235R

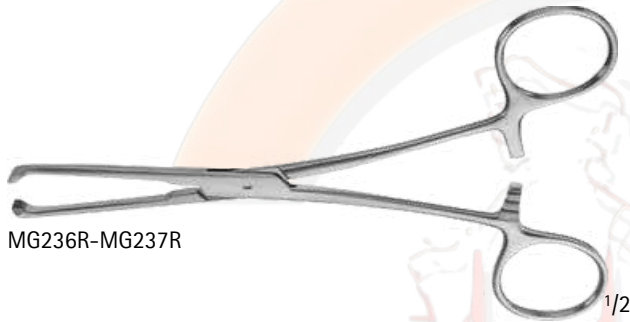

MG236R-MG237R



MG236R-MG237R

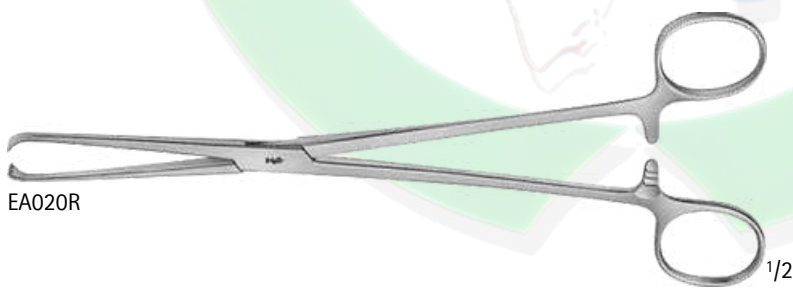

EA020R



EA020R

ALLIS Forceps, Heavy Version

| Catalog Number | Teeth | Length (in.) |
|----------------|-------|--------------|
| MG235R | 4 x 5 | 6 1/8 |
| MG236R | 5 x 6 | 6 1/8 |
| MG237R | 5 x 6 | 7 7/8 |

ALLIS-THOMS Forceps

| Catalog Number | Teeth | Length (in.) |
|----------------|-------|--------------|
| EA020R | 6 x 7 | 7 7/8 |



GENERAL SURGERY ABDOMINAL AND INTESTINAL GRASPING FORCEPS

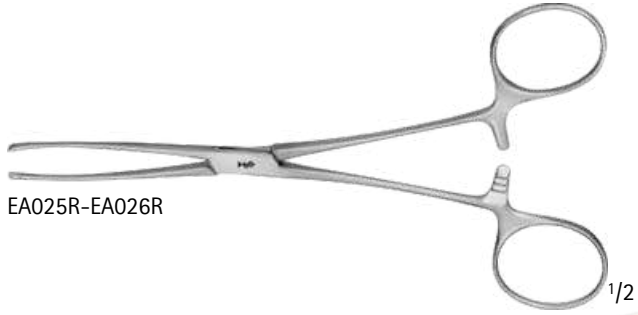

EA025R-EA026R

1/2



EA025R

1/1



EA026R

1/1

JUDD-ALLIS Forceps

| Catalog Number | Teeth | Length (in.) |
|----------------|-------|--------------|
| EA025R | 3 x 4 | 6 1/8 |
| EA026R | 3 x 4 | 7 7/8 |



MD568

1/2

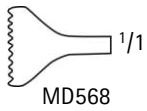

MD568

1/1

ALLIS-ADAIR Clamp

| Catalog Number | Teeth | Length (in.) |
|----------------|--------|--------------|
| MD568 | 9 x 10 | 6 1/4 |



MG455R

1/2



MG455R

1/1

LOCKWOOD-ALLIS Intestinal Clamp

| Catalog Number | Teeth | Length (in.) |
|----------------|-------|--------------|
| MG455R | 4 x 5 | 6 1/2 |





AMRAMED
TECH Pvt. Ltd.

Wholesale Supplier

Certified Register

A to Z Hospital Equipment and
Surgical Products B to C



GENERAL SURGERY ABDOMINAL AND INTESTINAL GRASPING FORCEPS

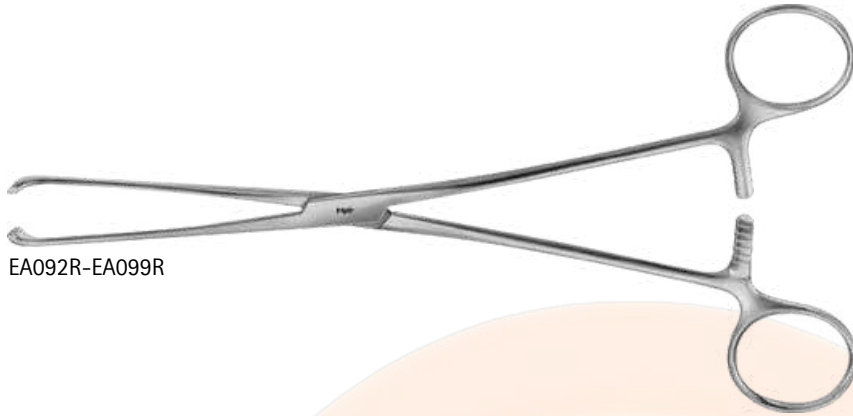

EA092R-EA099R

ALLIS Atraumatic Forceps

| Catalog Number | Length (in.) |
|----------------|--------------|
| EA092R | 6 1/4 |
| EA095R | 7 7/8 |
| EA096R | 8 3/4 |
| EA097R | 10 |
| EA100R | 11 5/8 |
| EA099R | 11 3/4 |
| EA101R | 14 |



EA092R



EA095R



EA096R



EA097R



EA099R

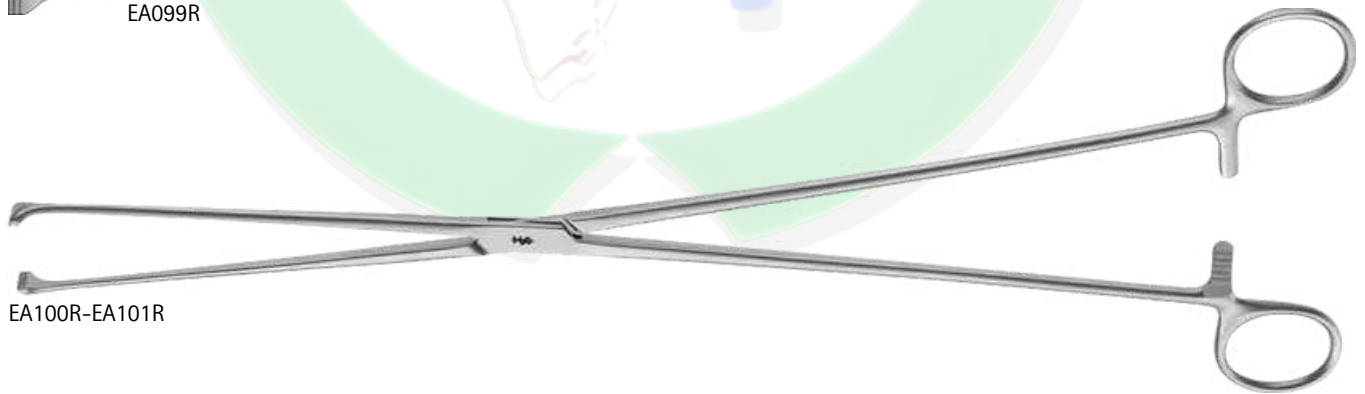

EA100R-EA101R

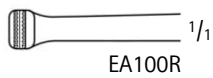

EA100R



EA101R



GENERAL SURGERY ABDOMINAL AND INTESTINAL GRASPING FORCEPS

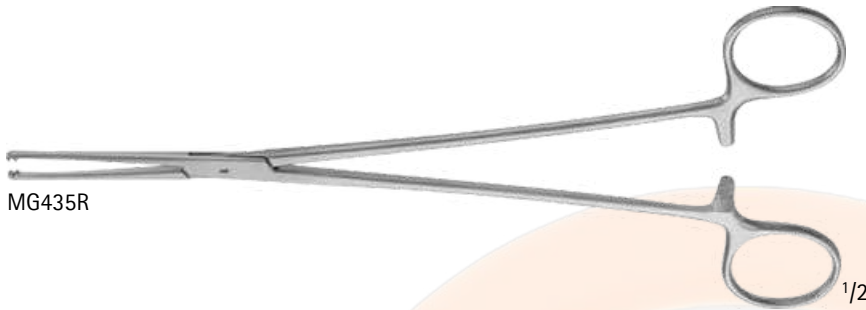

MG435R

**GLASSMAN-ALLIS Common Duct
Forceps Non-Crushing**

| Catalog Number | Length (in.) |
|----------------|--------------|
| MG435R | 8 1/2 |



MG435R

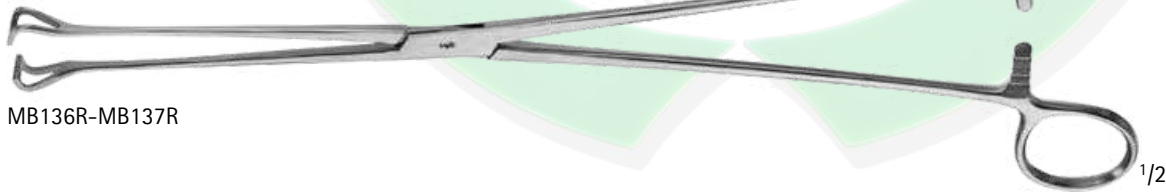

MB136R-MB137R

BABCOCK Tissue Holding Forceps

| Catalog Number | Length (in.) |
|----------------|--------------|
| MB136R | 12 |
| MB137R | 14 |



MB136R

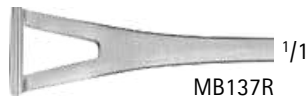

MB137R





GENERAL SURGERY ABDOMINAL AND INTESTINAL GRASPING FORCEPS



EA030R-MG359R



MG359R 1/1



EA030R 1/1



EA031R 1/1



EA032R 1/1

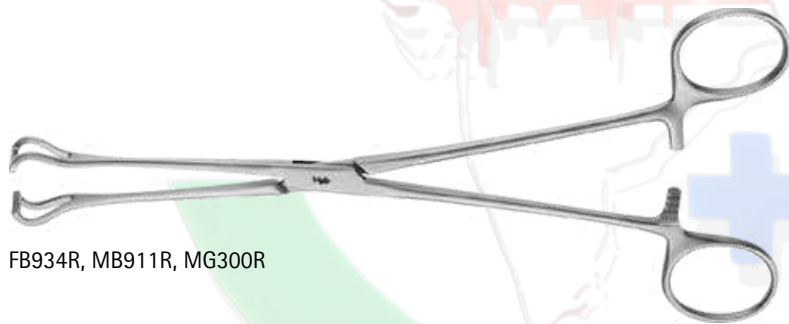

FB934R, MB911R, MG300R



FB934R, MB911R, MG300R 1/1

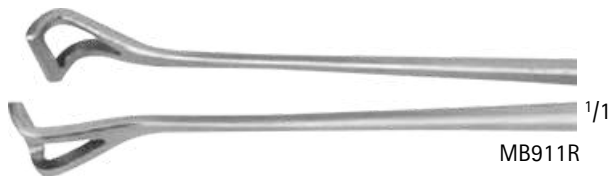

MB911R 1/1

BABCOCK Forceps

| Catalog Number | Tip | Length (in.) |
|----------------|-------------|--------------|
| MG359R | - | 5 1/2 |
| EA030R | - | 6 1/8 |
| EA031R | - | 6 7/8 |
| EA032R | - | 8 1/2 |
| FB934R | - | 8 3/4 |
| MB300R | - | 14 |
| MB911R | DEL, PETITE | 16 |



GENERAL SURGERY ABDOMINAL AND INTESTINAL GRASPING FORCEPS

BABCOCK Atraumatic Forceps

| Catalog Number | Length (in.) |
|----------------|--------------|
| EA050R | 6 1/4 |
| EA052R | 8 1/2 |
| FB936R | 8 3/4 |
| MD470 | 9 1/2 |



EA050R-EA052R

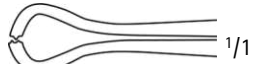

1/1



EA050R



1/1



EA052R

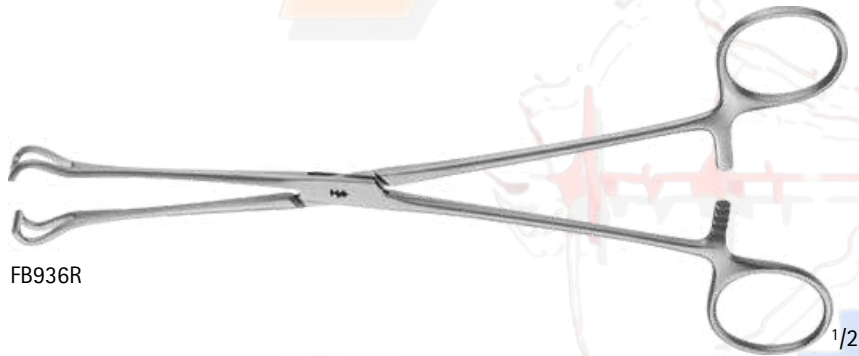

FB936R

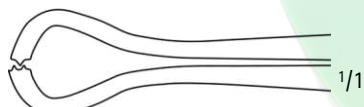

1/1



FB936R



MD470

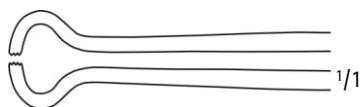

1/1



MD470

