



Wholesale Supplier Urology_Instrument A to Z Hospital Equipment and Surgical Products **B to C**



Urology

Needles	1298
Instruments for Radical Prostatectomy	1299 - 1302
Forceps and Clamps	1303 - 1313
Retractors	1314 - 1318
Catheters, Guides and Sounds	1319 - 1322

8275140877

9822688071

info@amramedtech.com



**Sr No.29/1/2, Adarsh Nagar,
Uruli Devachi, Hadapsar, Pune
Branches :- All Maharashtra**



amramedtech.com



UROLOGY NEEDLES

REVERDIN Needle

Catalog Number	Tip	Length (in.)
BM711R	SLIGHT-CVD	7 3/4
BM712R	CVD	7 3/4
BM713R	HEAVY-CVD	7 3/4
BM714R	X-HEAVY-CVD	7 3/4
BM726R	SLIGHT-CVD	9
BM727R	CVD	9
BM728R	HEAVY-CVD	9
BM729R	X-HEAVY-CVD	9



BM711R-BM714R



BM711R



BM711R



BM712R



BM713R



BM714R



BM726R-BM729R



BM726R



BM726R



BM727R



BM728R



BM729R





UROLOGY BARRÉ INSTRUMENTS FOR RADICAL PROSTATECTOMY

BARRÉ Scalpel Handle #3L, F/ Blade nos. 10-15, 40, 42

Catalog Number	Blade Shape	Blade Angle	Length (in.)
BB176R	ANG	12°	9 3/4



BB176R



BB176R

BARRÉ Scalpel Handle #3XL, F/ Blade nos. 10-15, 40, 42

Catalog Number	Blade Shape	Length (in.)
BB177R	STR	9 3/4



BB177R



BB177R

BARRÉ Scalpel Handle #3XL, F/ Blade nos. 10-15, 40, 42

Catalog Number	Blade Shape	Blade Angle	Length (in.)
BB178R	ANG	25°	9 3/4



BB178R



BB178R



UROLOGY



UROLOGY BARRÉ INSTRUMENTS FOR RADICAL PROSTATECTOMY

Dorsal Venous Complex Clamp

Catalog Number	Blade Angle	Length (in.)
EF167R	10°	8 1/4

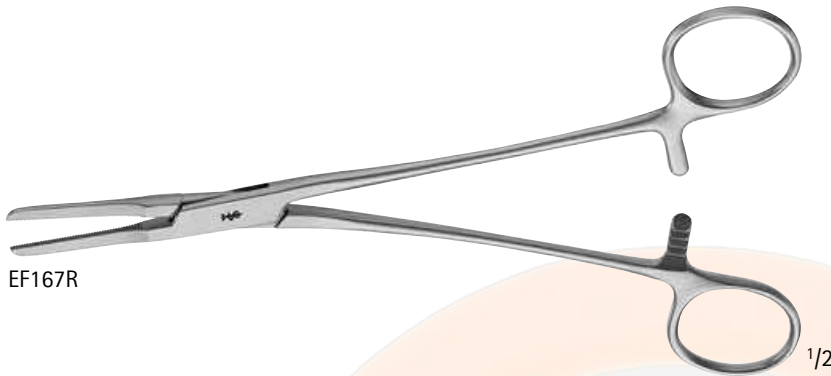

EF167R



EF167R

BARRÉ Nerve Sparing Scissors

Catalog Number	Tip	Blade Shape	Length (in.)
BC715R	S/S	CVD	11



BC715R

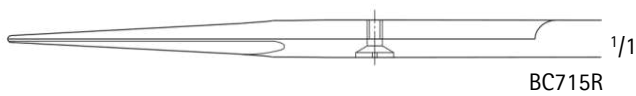

BC715R





UROLOGY BARRÉ INSTRUMENTS FOR RADICAL PROSTATECTOMY

BARRÉ Nerve Sparing Dissector

Catalog Number	Tip	Length (in.)
BJ029R	X-FINE	11
BJ110R	FINE	11

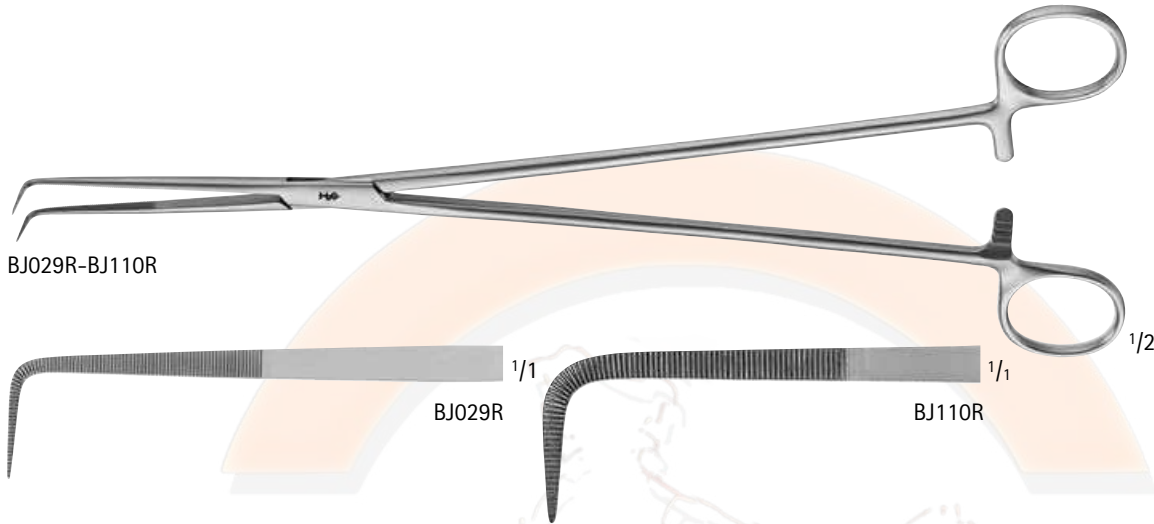

BARRÉ Prostate Retractor

Catalog Number	Length (in.)
BT680R	14 1/4

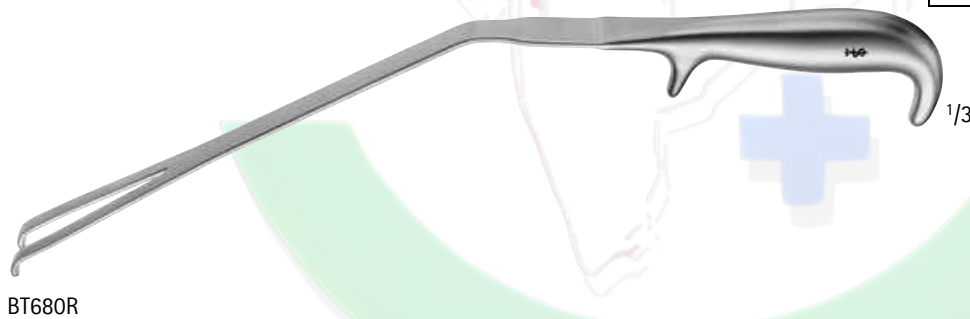

BARRÉ Urethra Retractor

Catalog Number	Tip	Length (in.)
BT682R	SMALL	10 1/4
BT683R	LARGE	10 1/4
BT681R	—	15 3/8





UROLOGY BARRÉ INSTRUMENTS FOR RADICAL PROSTATECTOMY

BARRÉ Suture Holding Frame

Catalog Number	Length (in.)
BV927R	18 1/4

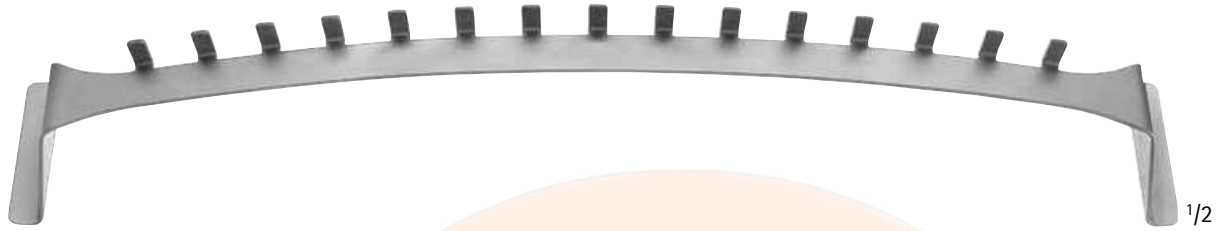

BV927R

BARRÉ Prostatectomy Retractor

Catalog Number	Description	Blade Size, Depth x Width (in.)	Length (in.)
BV921R	COMPLETE RETRACTOR SYSTEM	-	-
BV922R	RETRACTOR ONLY	-	-
BV840R	MUENSTER OCTANGULAR NOTCH ROD	-	7 7/8
BV849R	MUENSTER UNIVERSAL CONNECTING CLAMP	-	2 3/8
BV925R	BARRÉ COLD LIGHT SUPPORT	-	-
BV924R	BARRÉ RETRACTOR BLADES PAIR OF BLADES 2" DEPTH x 2 1/4" WIDTH	2 x 2 3/4	-
BV926R	LATERAL BLADE MALLEABLE 2" DEPTH x 7 1/2" WIDTH	2 x 7 1/2	7 1/2
BV929R	CENTER BLADE 2 1/4" DEPTH x 2 3/4" WIDTH	2 1/4 x 2 3/4	9 1/4

BV921R Full Set includes:

- BV922R
- BV840R
- BV849R
- BV925R
- BV924R
- BV926R
- BV929R



BV921



BV922



BV840



BV849



BV925



BV924



BV926

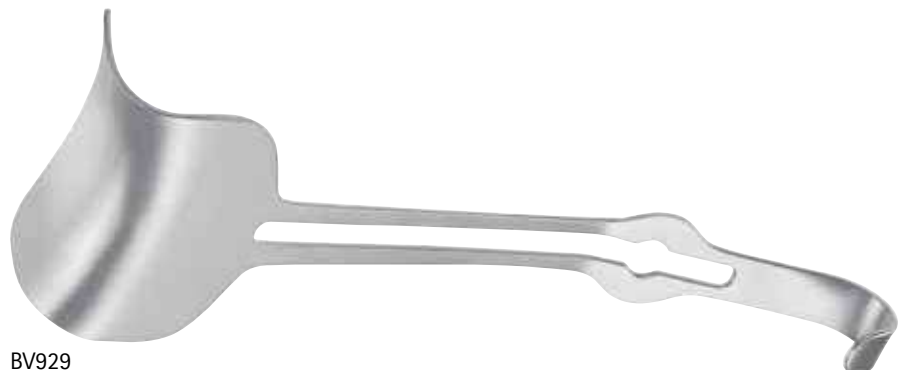

BV929



UROLOGY

MILLIMETERS



UROLOGY FORCEPS AND CLAMPS



GUYON Atraumatic Kidney Clamp

Catalog Number	Length (in.)
EF002R	9
EF001R	9 1/2

EF002R-EF001R

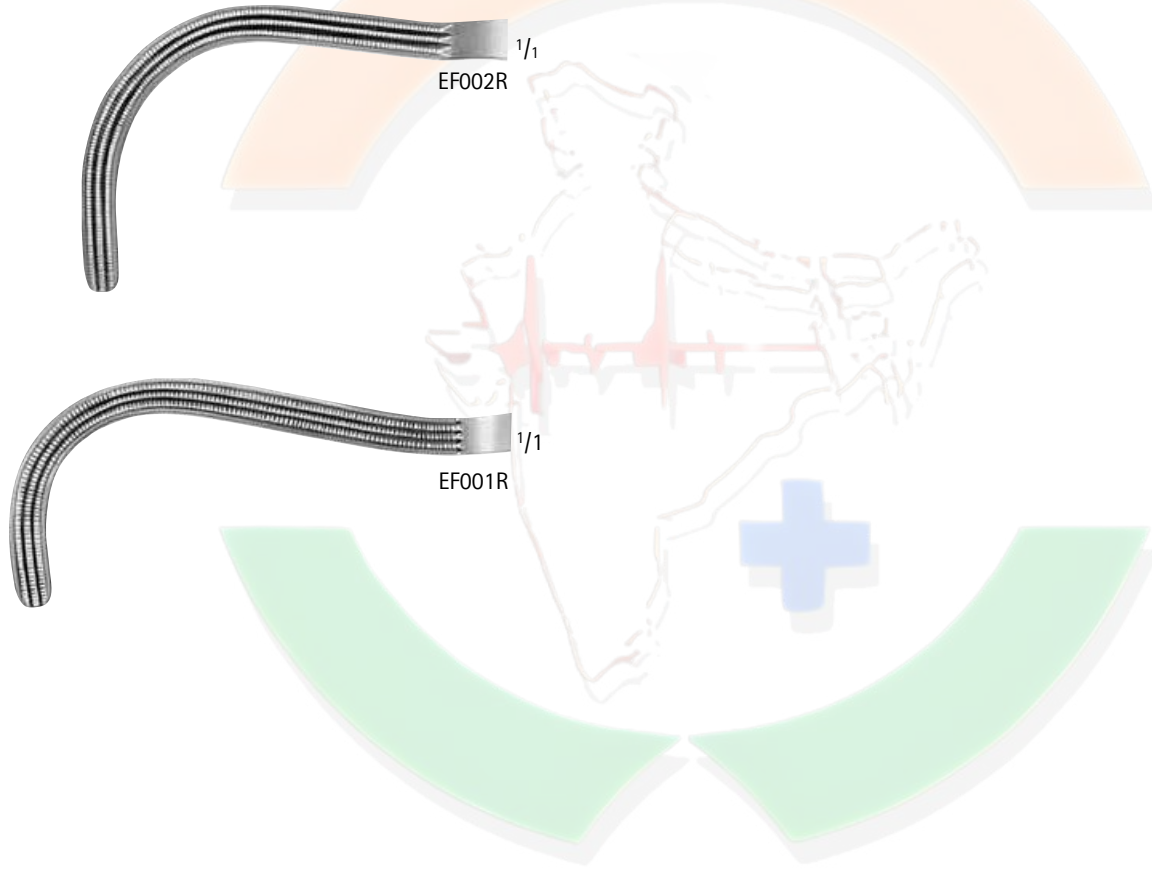



UROLOGY FORCEPS AND CLAMPS

GUYON Kidney Clamp

Catalog Number	Length (in.)
EF011R	9
EF010R	9 1/4
EF012R	11

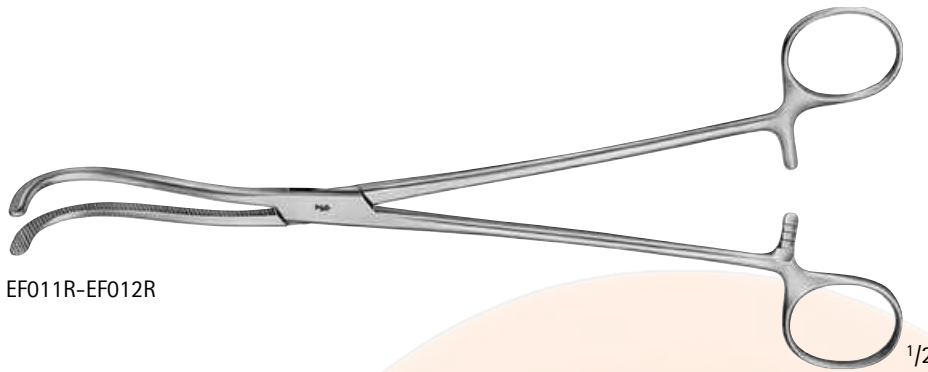

EF011R-EF012R

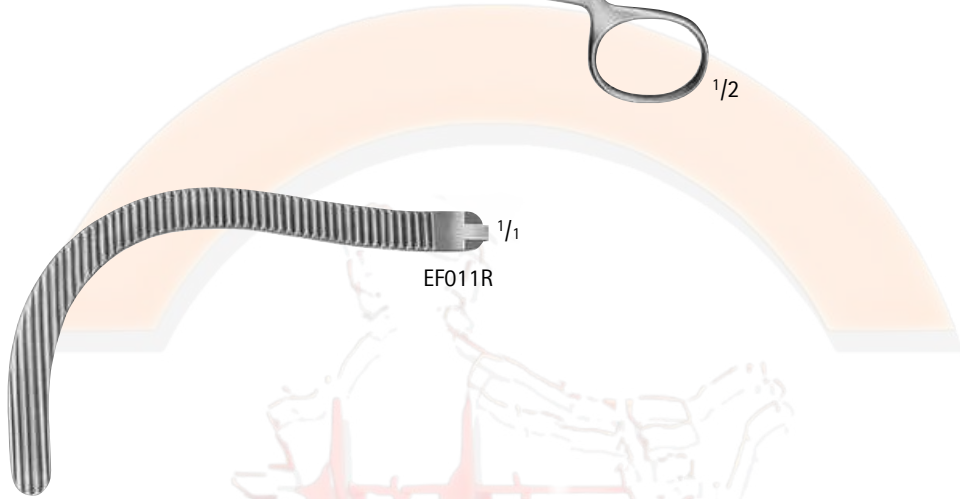

EF011R

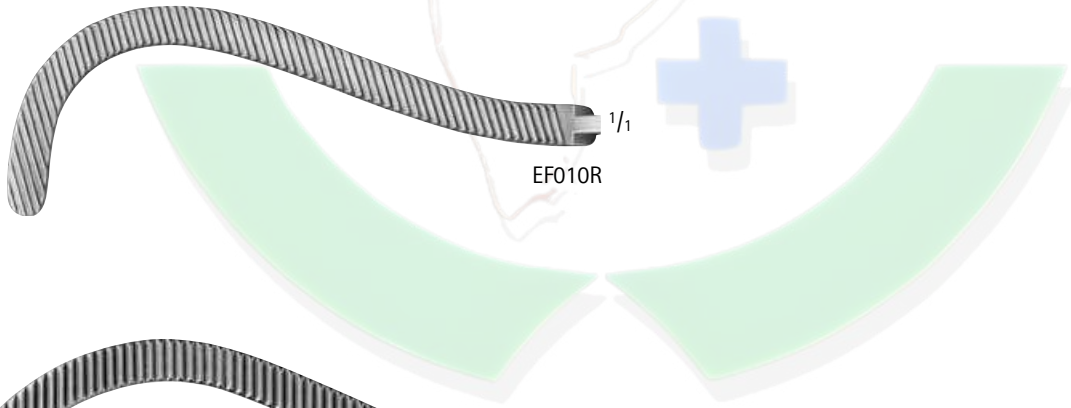

EF010R



EF012R

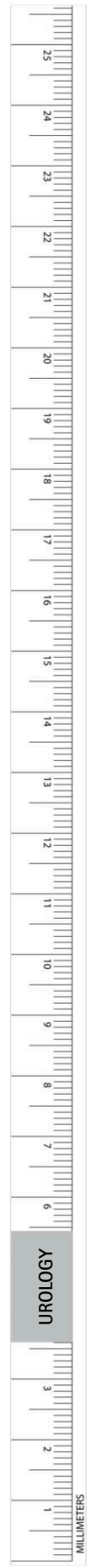



UROLOGY FORCEPS AND CLAMPS

STILLE Kidney Clamp

Catalog Number	Length (in.)
EF016R	8 7/8
EF015R	9 1/2

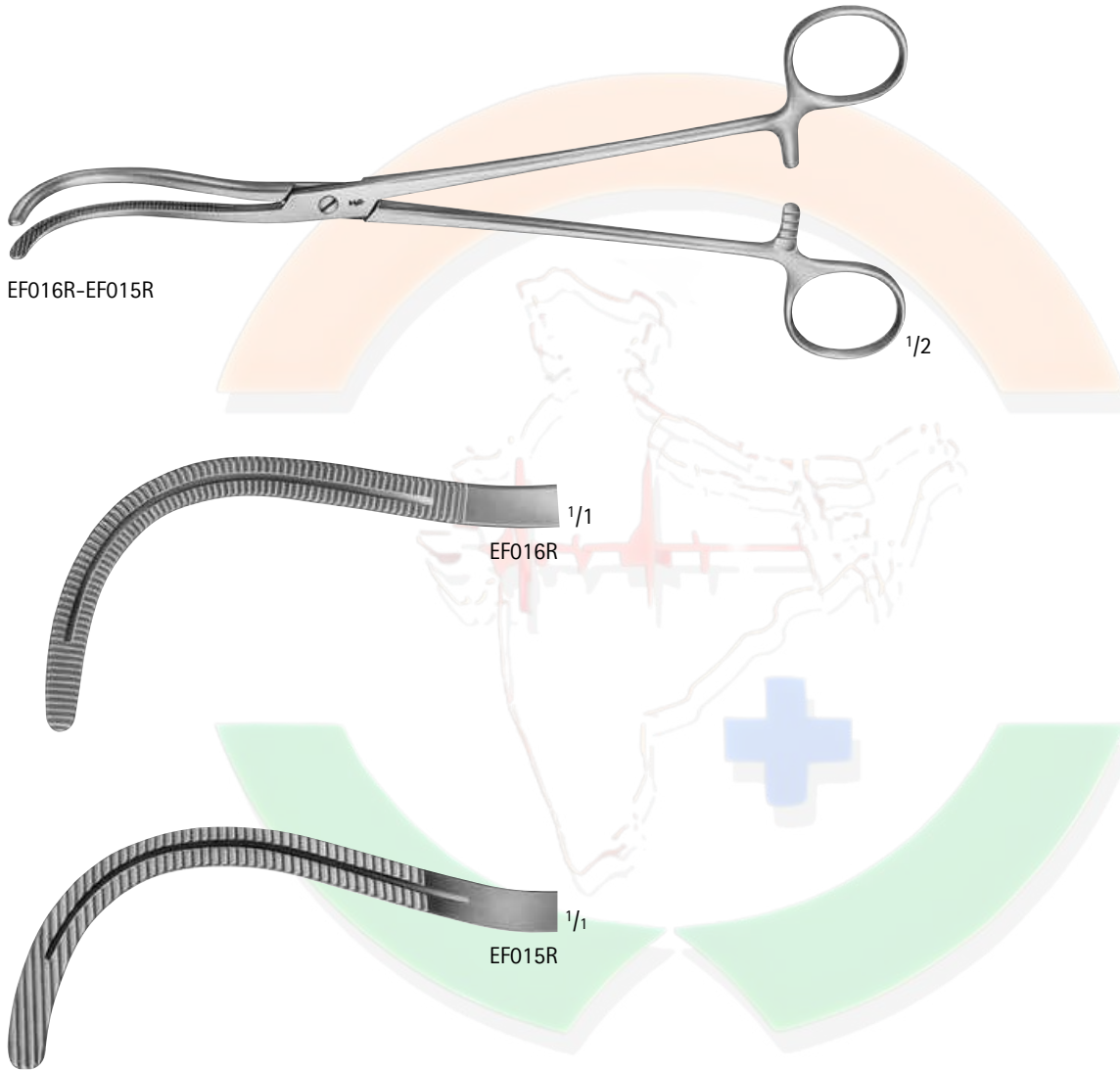



UROLOGY FORCEPS AND CLAMPS

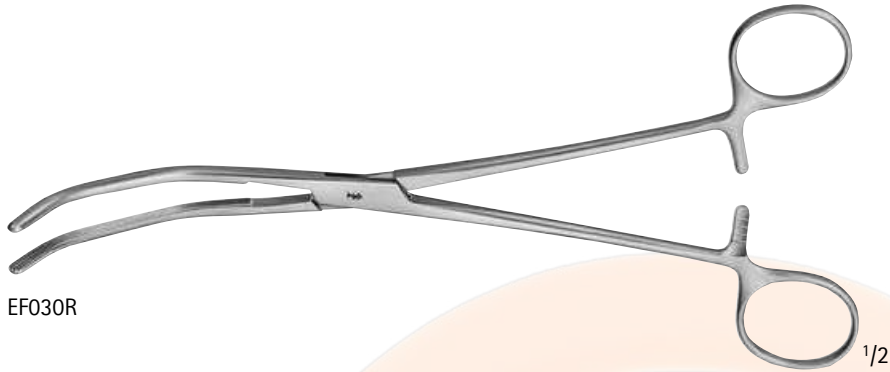

HERRICK Kidney Clamp

Catalog Number	Length (in.)
EF030R	8 7/8



Ureter Atraumatic Forceps

Catalog Number	Length (in.)
EF070R	9 1/2

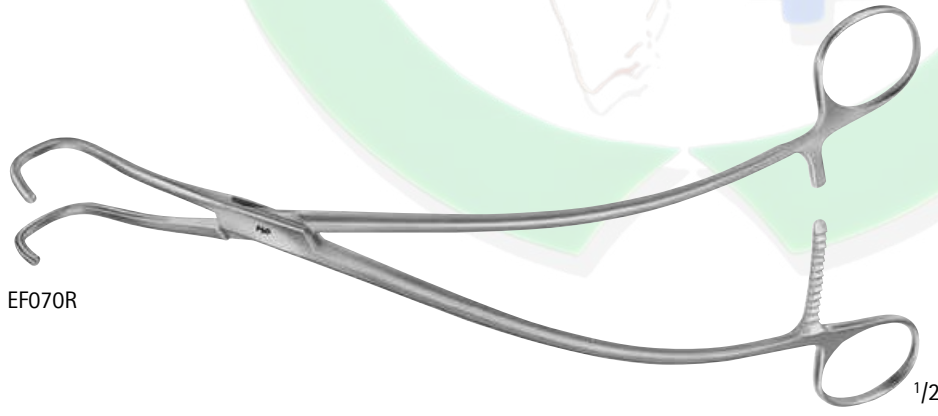



UROLOGY FORCEPS AND CLAMPS



EF048R-EF047R



EF047R



EF048R

HEIMING Kidney Stone Forceps

Catalog Number	Jaw	Length (in.)
EF047R	SLIGHT-CVD	6 3/4
EF048R	HEAVY-CVD	6 1/4

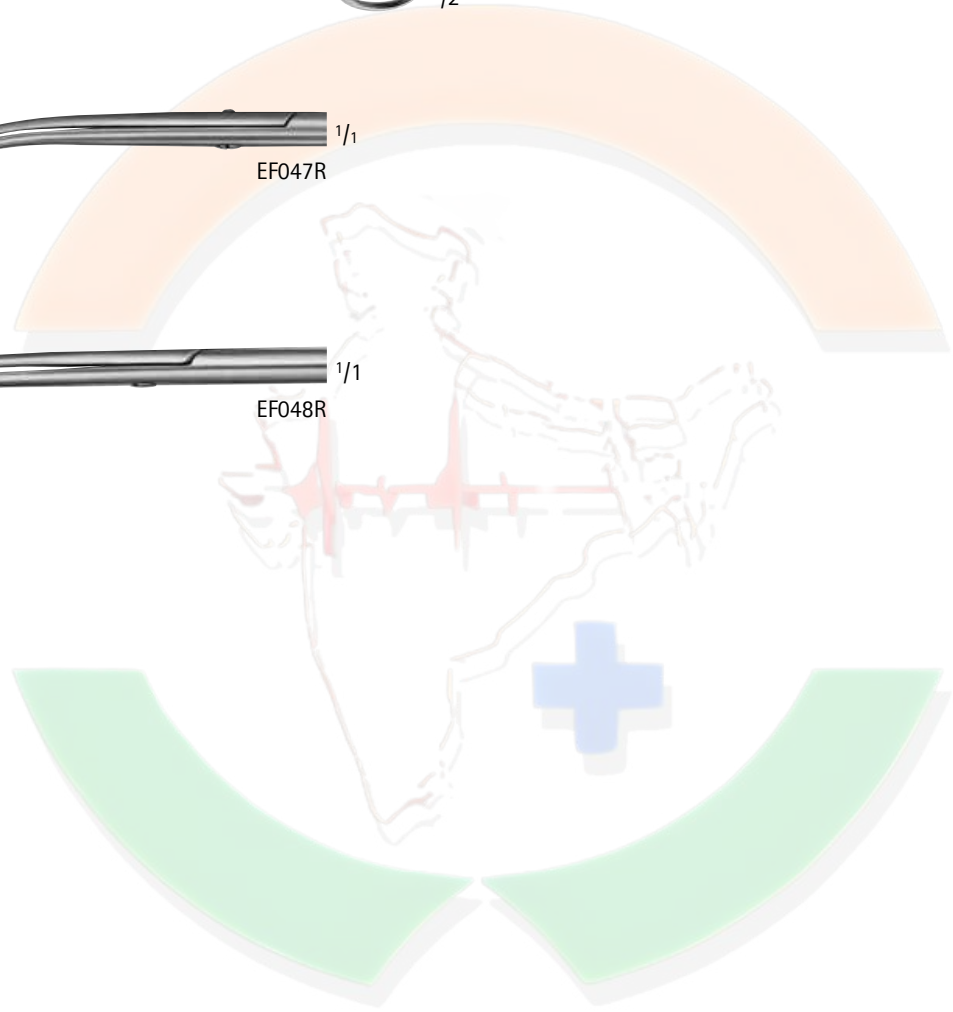

UROLOGY



AMRAMED
TECH Pvt. Ltd.

Wholesale Supplier

A to Z Hospital Equipment and
Surgical Products B to C



Certified Register

UROLOGY FORCEPS AND CLAMPS

RANDALL Kidney Stone Forceps

Catalog Number	Jaw	Length (in.)
EF055R	CVD	7 1/2
EF056R	HEAVY-CVD	7 1/2

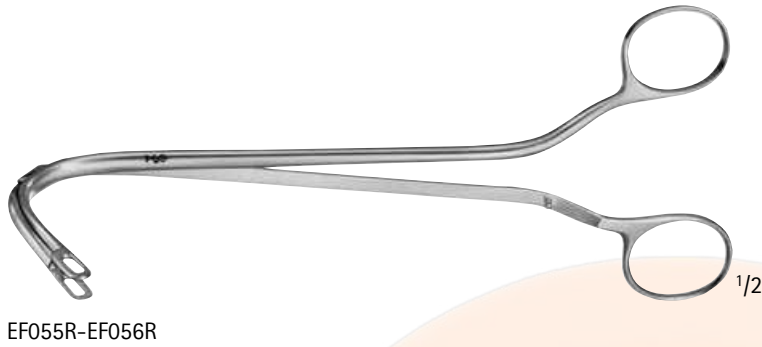

EF055R-EF056R

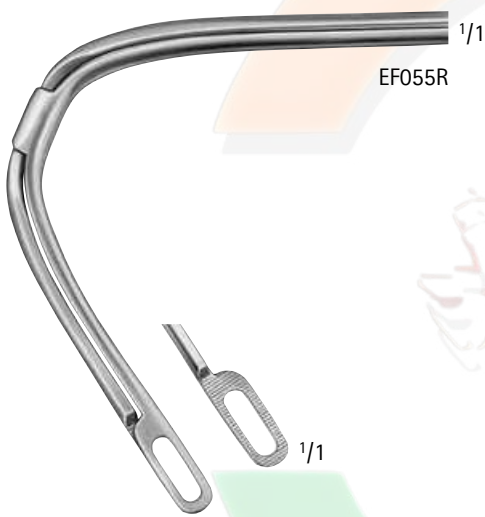

EF055R

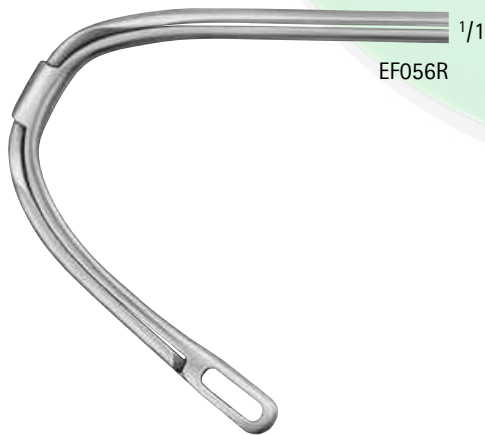

EF056R

UROLOGY

MILLIMETERS



UROLOGY FORCEPS AND CLAMPS



EF051R-EB244R

**RANDALL Kidney Stone Forceps
(continued)**

Catalog Number	Jaw	Length (in.)
EF051R	SLIGHT-CVD	8 7/8
EF052R	CVD	8 7/8
EF053R	HEAVY-CVD	8 7/8
EB246R	HEAVY CVD, VERY DELICATE	9
EF054R	U-CVD	8 7/8
EB244R	90° ANG	9 5/8

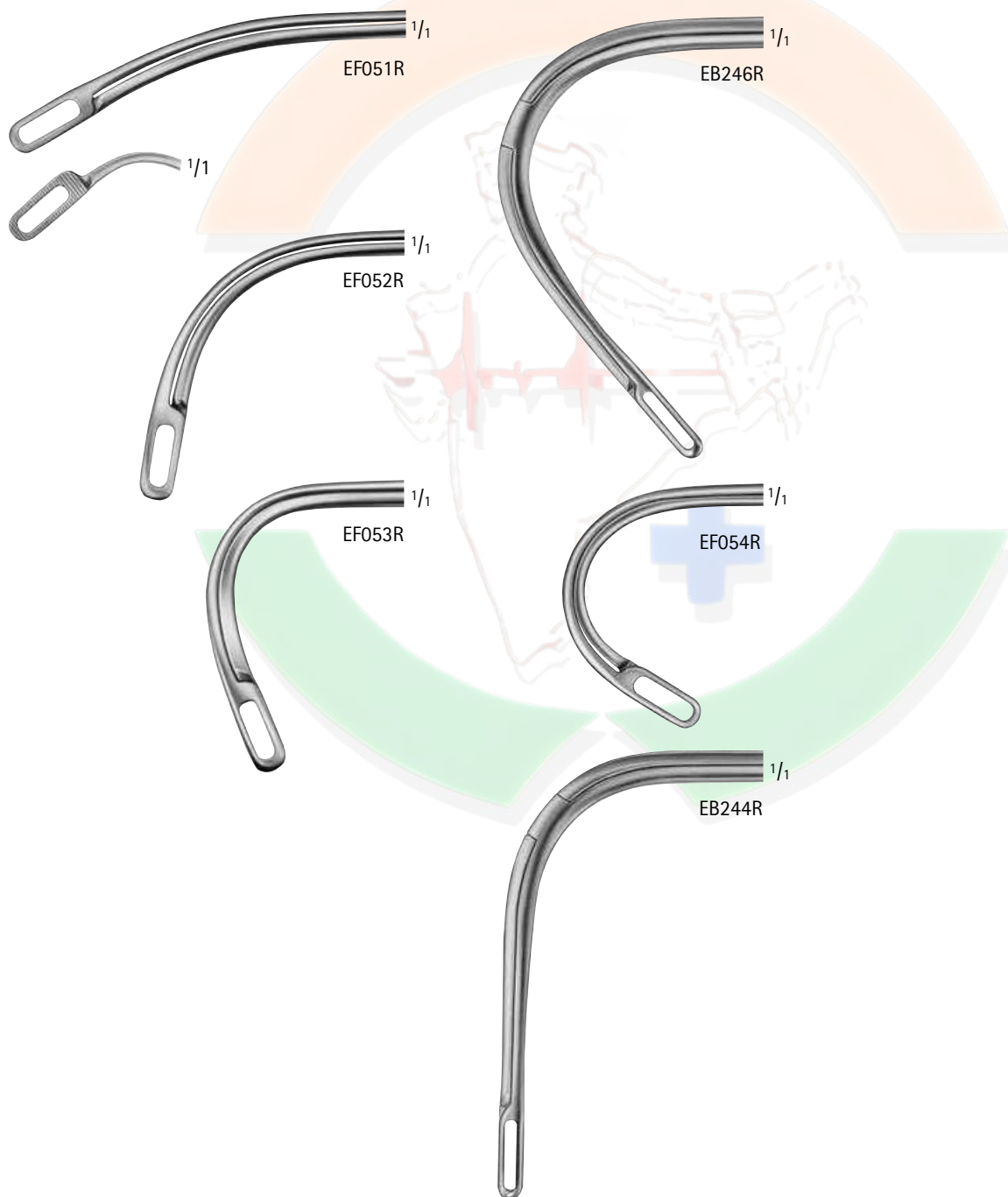



UROLOGY FORCEPS AND CLAMPS

Genitourinary Forceps (F/ No Scalpel Set)

Catalog Number	Length (in.)
EF155R	5

MILLIN Atraumatic Lobe Forceps

Catalog Number	Length (in.)
EF163R	9 5/8

MILLIN Atraumatic T-Shaped Lobe Forceps

Catalog Number	Length (in.)
EF164R	9 1/4

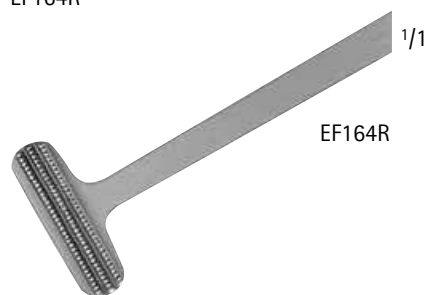
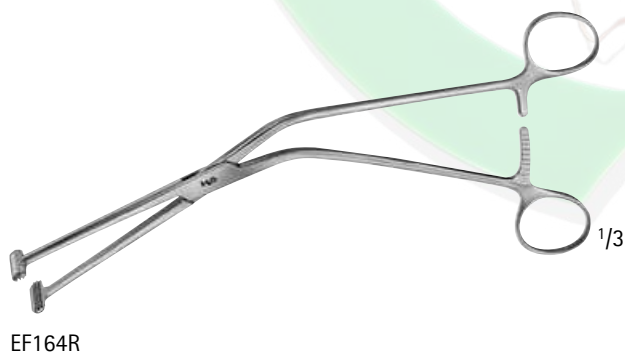
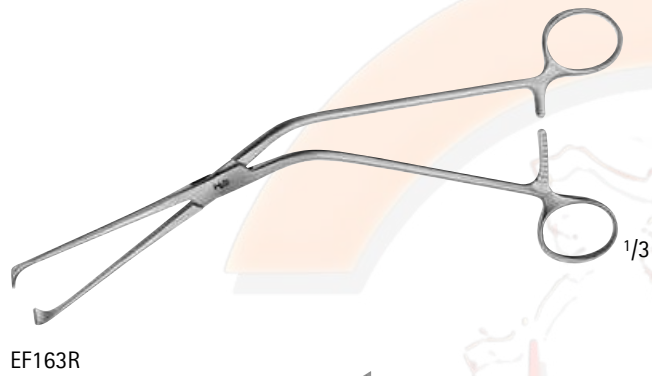
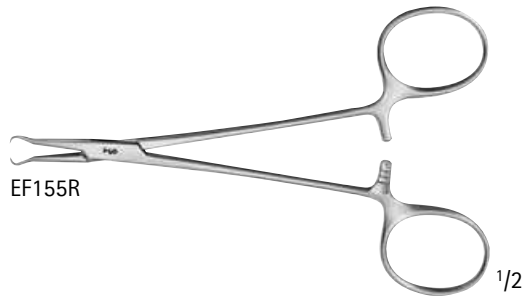



UROLOGY FORCEPS AND CLAMPS

MATHIEU Foreign Body Forceps

Catalog Number	Shaft Length (in.)
EF928R	7 1/2

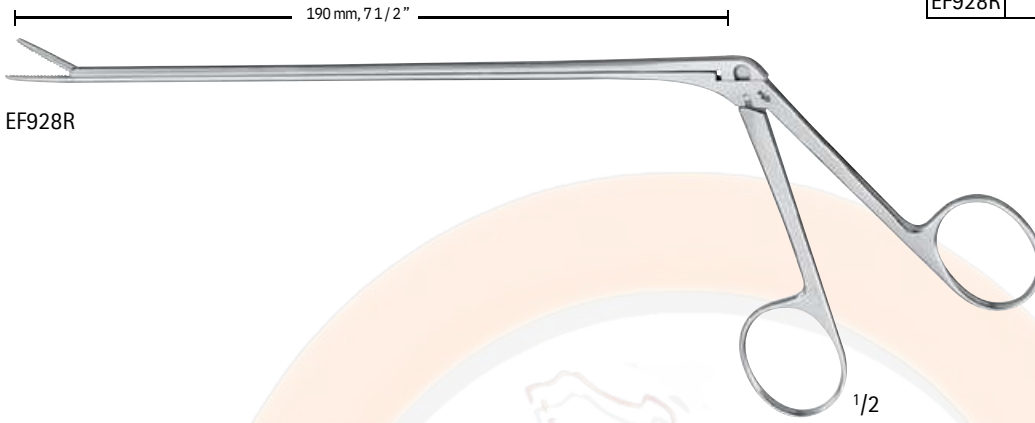

Spermatic Cord Fixation Clamp

Catalog Number	Length (in.)
EF195R	5 3/4



LEADER Vas Isolation Forceps

Catalog Number	Length (in.)
MG452R	5 1/4

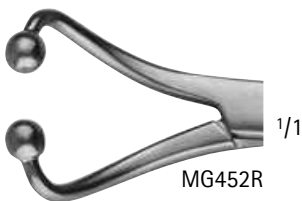



UROLOGY FORCEPS AND CLAMPS

SANDERS Vasectomy Forceps

Catalog Number	Tip	Length (in.)
MG453R	x 1 PRONGS	6 1/8



STOCKMANN Penis Clamp

Catalog Number	Length (in.)
EF400R	2 3/4



STRAUSS Penis Clamp

Catalog Number	Length (in.)
EF401R	5 1/8



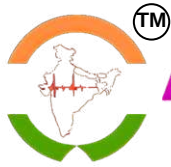

UROLOGY FORCEPS AND CLAMPS



MG207R

ZIPSER Meatus Clamp

Catalog Number	Length (in.)
MG207R	4 1/4

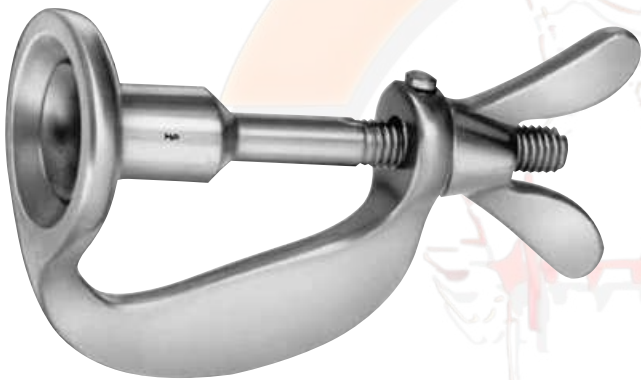

EF965R-EF967R

WINKELMANN Circumcision Clamp

Catalog Number	Diameter (mm)
EF965R	12
EF966R	16
EF967R	20

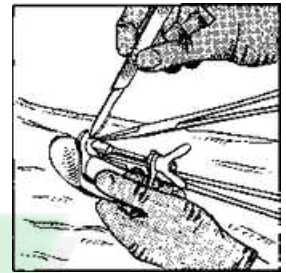
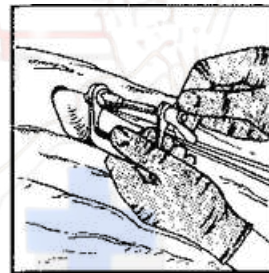

Assisted by two hemostats or ligatures the foreskin is pushed over the bell-shaped protection rod and the glans is placed into it. Next, the wing-nut is tightened as close as possible, so the foreskin is annular compressed. The foreskin is cut off with a scalpel adjacent to the compression ring. The circumcision clamp remains in place for a few minutes to avoid bleeding. If any large vein, specially the frenular artery, is cut, a ligature must be set. The advantage of the method described is the cosmetically favorable scar which is left after rejection of the small necrotized portion.





UROLOGY RETRACTORS

LOWSLEY Prostatic Tractor

Catalog Number	Tip	Tip Size (FR)	Working Length (in.)	Length (in.)
MG080R	STR	20	9	12 1/4
MG079R	CVD	20	9 1/2	12 3/4



MG080R-MG079R

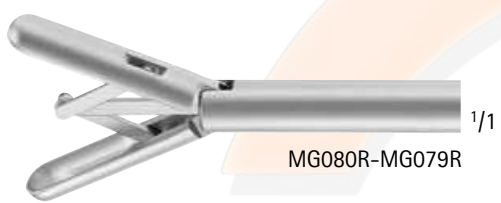

MG080R-MG079R

1/1

YOUNG Prostatic Tractor, Short

Catalog Number	Tip Size (mm)	Length (in.)
MG250R	25 x 25	8 5/8

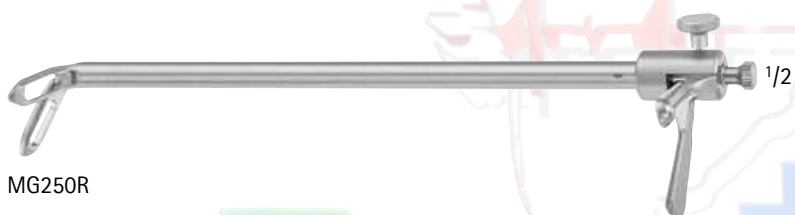

MG250R

1/2

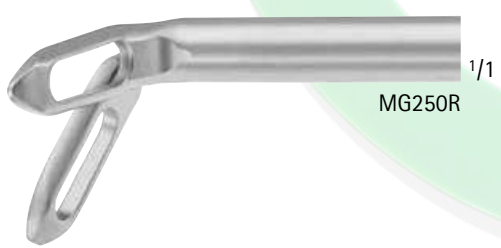

MG250R

1/1

LEGUEU Bladder Spatula Retractor

Catalog Number	Blade Size (mm)	Length (in.)
BV928R	35 / 90	10 1/4



BV928R

1/3

90 mm, 3 1/2"

35 mm, 1 3/8"





AMRAMED
TECH Pvt. Ltd.

Wholesale Supplier

A to Z Hospital Equipment and
Surgical Products B to C



Certified Register

UROLOGY RETRACTORS

WYLIE Renal Vein Retractor

Catalog Number	Blade Size (mm)	Length (in.)
MG179R	25 x 100	13 3/4
MG066R	25 x 175	12 3/4

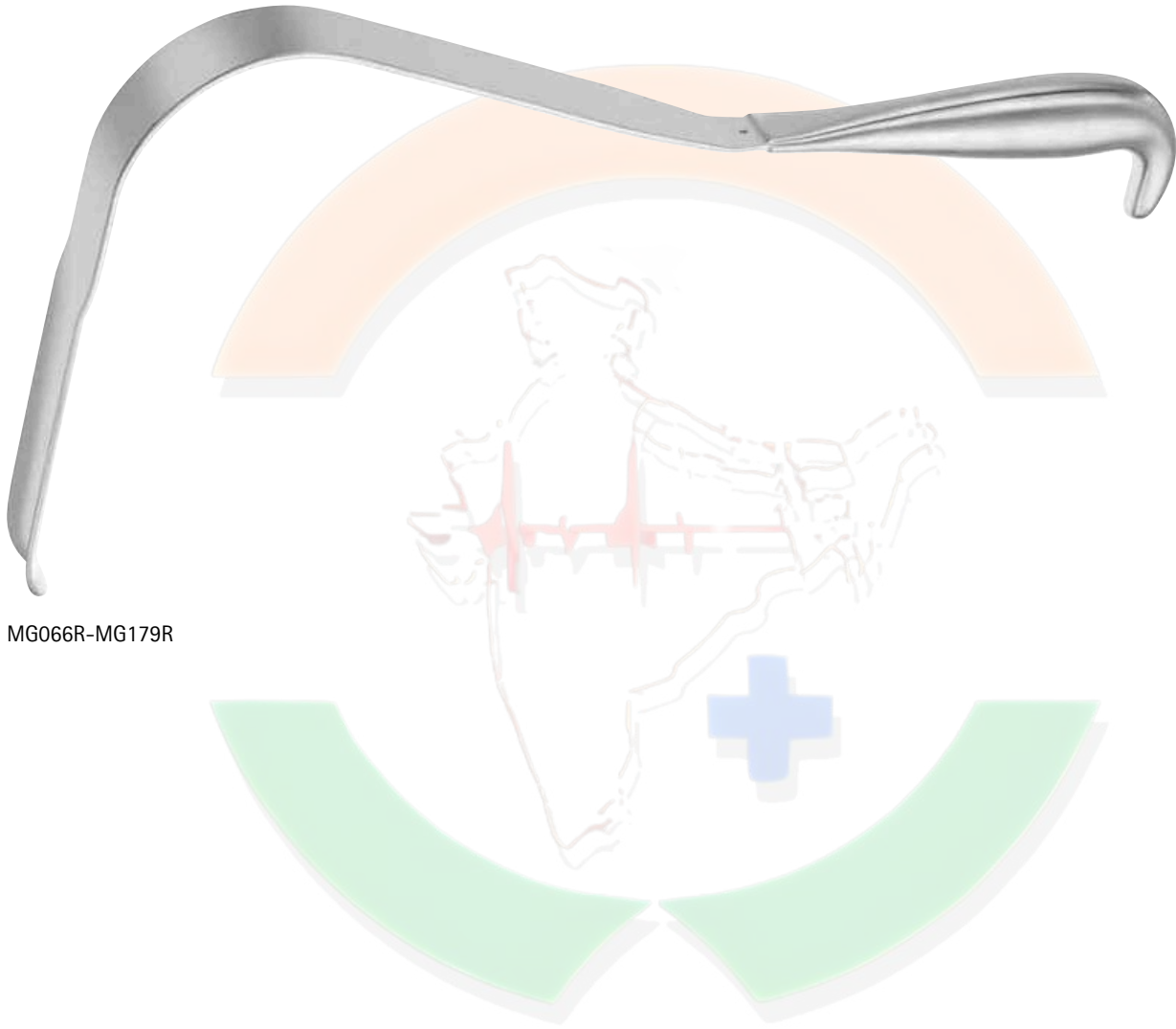



UROLOGY RETRACTORS

YOUNG Bulb Retractor

Catalog Number	Blade Size (mm)	Length (in.)
MG248R	25 x 25	8 5/8



MG248R

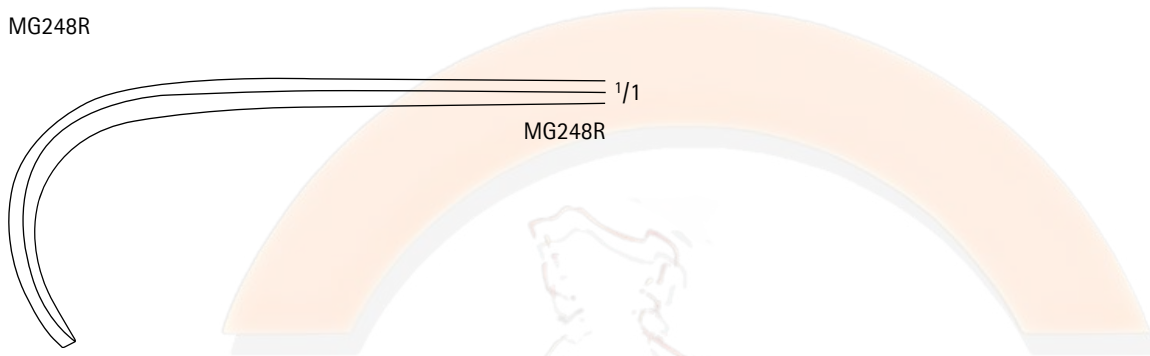

MG248R 1/1

YOUNG Prostatic Retractor, Bifurcated Blade W/ Deep Slots

Catalog Number	Blade Size (mm)	Length (in.)
MG249R	1 1/2 x 1 5/8	7 7/8

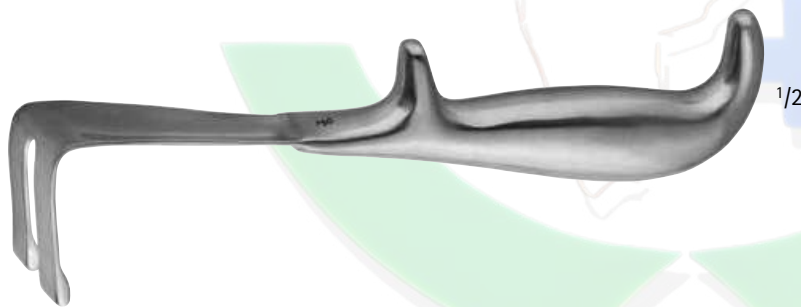

MG249R

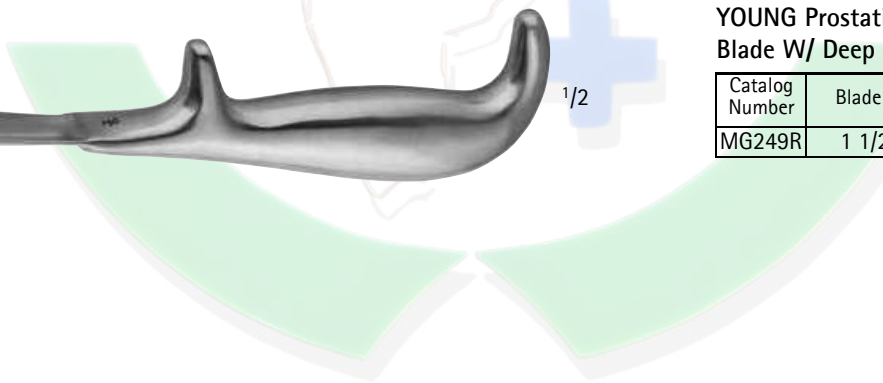

1/2





UROLOGY RETRACTORS



MG180R

YOUNG Lateral Retractor

Catalog Number	Blade Size (mm)	Length (in.)
MG180R	50 x 11	8 1/4

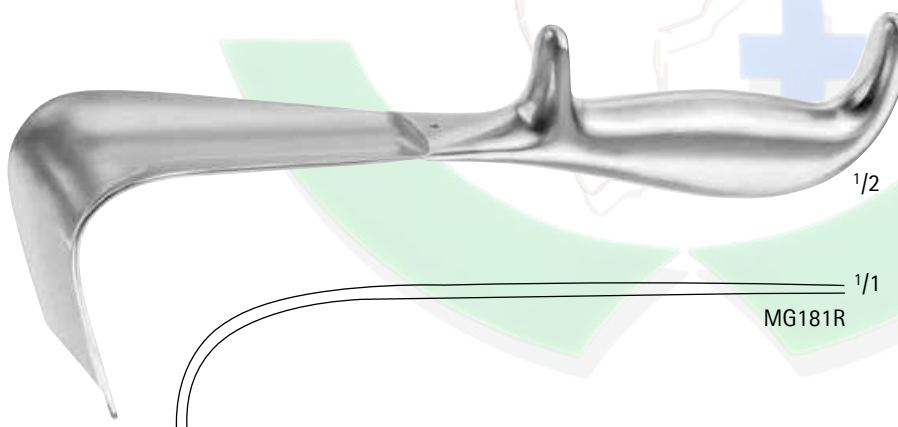
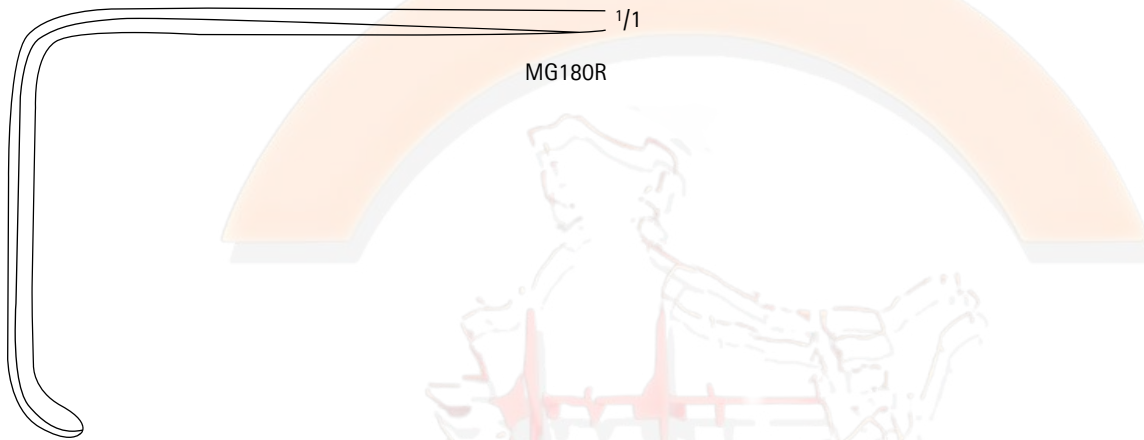

MG181R

YOUNG Anterior Retractor

Catalog Number	Blade Size (mm)	Length (in.)
MG181R	60 x 40	7 5/8

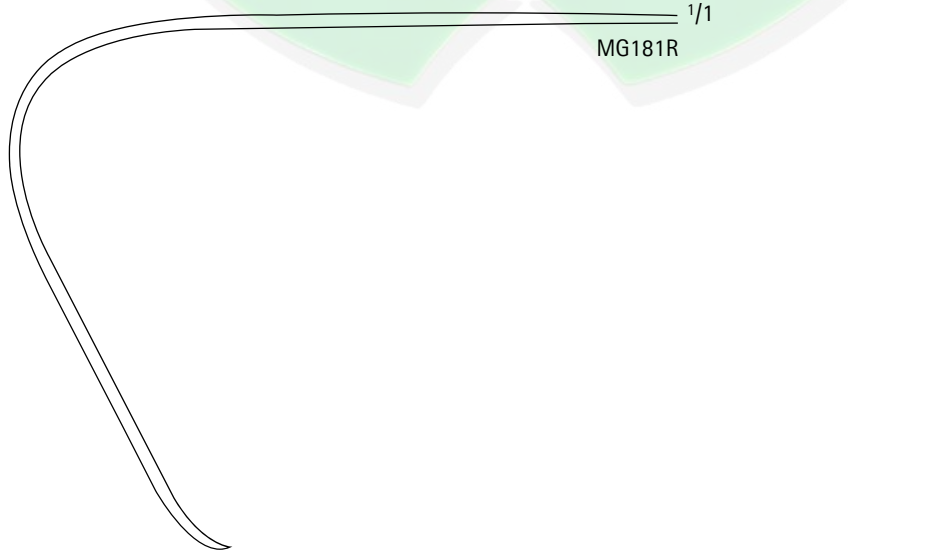

UROLOGY



UROLOGY RETRACTORS



GIL VERNET Vein Retractor

Catalog Number	Blade Size (mm)	Length (in.)
BT210R	10 x 4	9 1/2
BT211R	10 x 6	9 1/2
BT212R	10 x 8	9 1/2
BT213R	10 x 11	9 1/2
BT214R	13 x 15	9 1/2
BT215R	13 x 17	9 1/2
BT216R	14 x 20	9 1/2
BT217R	16 x 23	9 1/2

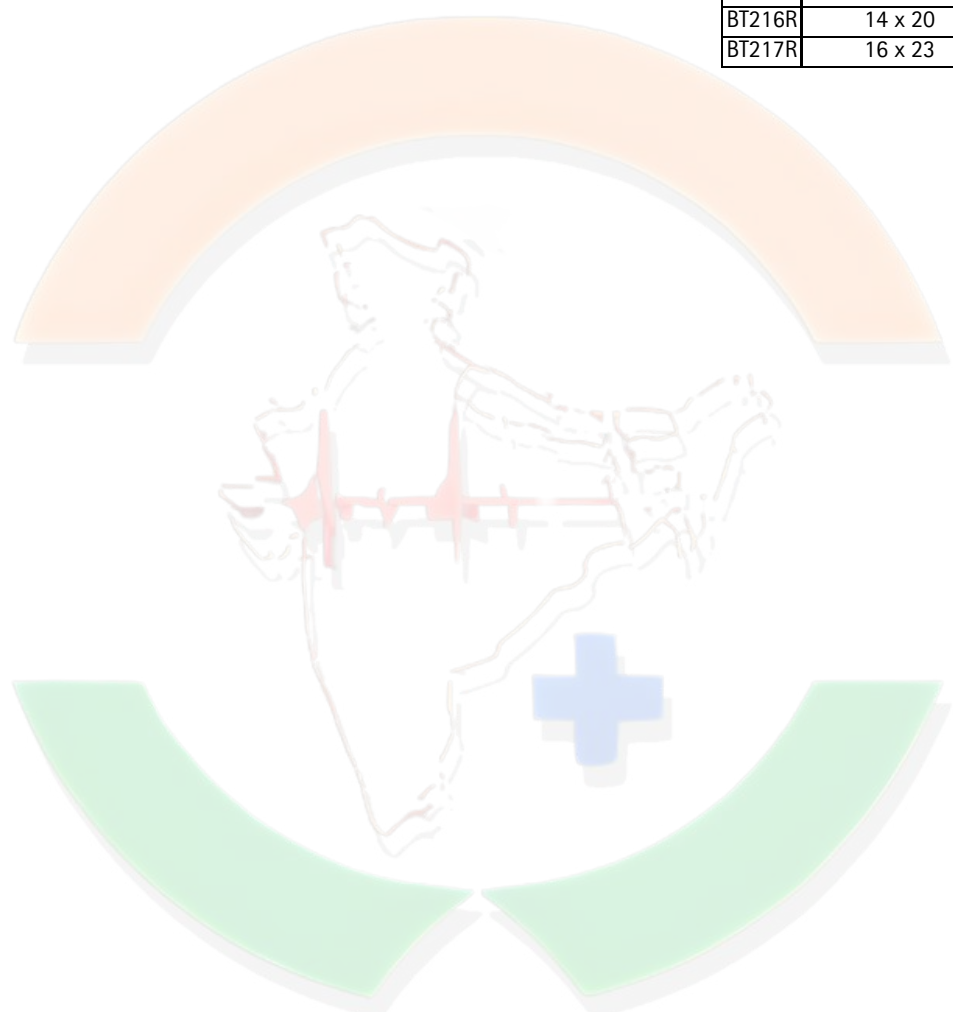

BV580R-BV578R



MILLIN Bladder Retractor

Catalog Number	Description
BV580R	COMPLETE SET
BV575R	SPREADER
BV576R	BLADES, 57 x 25 MM
BV577R	BLADES, 82 x 25 MM
BV578R	CENTER BLADE, 105 x 45 MM

BV580R Includes:

- 1 Spreader BV575R
- 1 Center Blade BV578R
- 2 Blades of each BV576R and BV577R



UROLOGY CATHETERS / GUIDES / SOUNDS

Female Catheter, Metal

Catalog Number	Tip Size (FR)	Length (in.)
EF306C	6	6 1/4
EF308C	8	6 1/4
EF310C	10	6 1/4
EF312C	12	6 1/4
EF314C	14	6 1/4
EF316C	16	6 1/4
EF318C	18	6 1/4



GUYON Wire Catheter Guide, Rigid

Catalog Number	Blade	Tip Size (FR)	Length (in.)
EF492R	CVD	7	14 3/8



JEWETT Urethral Sound

Catalog Number	Tip Size (FR)	Shape	Length (in.)
MG240R	12	STR	9 1/2
MG241R	14	STR	9 1/2
MG242R	16	STR	9 1/2
MG243R	18	STR	9 1/2
MG244R	20	STR	9 1/2
MG245R	22	STR	9 1/2
MG246R	24	STR	9 1/2
MG247R	26	STR	9 1/2
MG128R	28	STR	9 1/2
MG129R	30	STR	9 1/2
MG130R	32	STR	9 1/2





UROLOGY CATHETERS / GUIDES / SOUNDS



EF638R-EF660R

DITTEL Urethral Sound

Catalog Number	Tip Size (FR)	Length (in.)
EF638R	8	13 1/2
EF639R	9	13 1/2
EF640R	10	13 1/2
EF641R	11	13 1/2
EF642R	12	13 1/2
EF643R	13	13 1/2
EF644R	14	13 1/2
EF645R	15	13 1/2
EF646R	16	13 1/2
EF647R	17	13 1/2
EF648R	18	13 1/2
EF649R	19	13 1/2
EF650R	20	13 1/2
EF651R	21	13 1/2
EF652R	22	13 1/2
EF653R	23	13 1/2
EF654R	24	13 1/2
EF655R	25	13 1/2
EF656R	26	13 1/2
EF657R	27	13 1/2
EF658R	28	13 1/2
EF659R	29	13 1/2
EF660R	30	13 1/2



MG131R-MG139R

CAMPBELL Miniature Sound

Catalog Number	Tip Size (FR)	Length (in.)
MG131R	6	9 1/2
MG132R	8	9 1/2
MG133R	10	9 1/2
MG134R	12	9 1/2
MG135R	14	9 1/2
MG136R	16	9 1/2
MG137R	18	9 1/2
MG138R	20	9 1/2
MG139R	22	9 1/2



UROLOGY

MILLIMETERS



UROLOGY CATHETERS / GUIDES / SOUNDS



MB805R-MB884R

MCCREA Urethral Sound, Infant/Female

Catalog Number	Tip Size (FR)	Length (in.)
MB805R	8	7 1/4
MB806R	10	7 1/4
MB809R	12	7 1/4
MB810R	14	7 1/4
MB811R	16	7 1/4
MB813R	18	7 1/4
MB814R	20	7 1/4
MB815R	22	7 1/4
MB838R	24	7 1/4
MB839R	26	7 1/4
MB840R	28	7 1/4
MB881R	30	7 1/4
MB882R	32	7 1/4
MB883R	34	7 1/4
MB884R	36	7 1/4

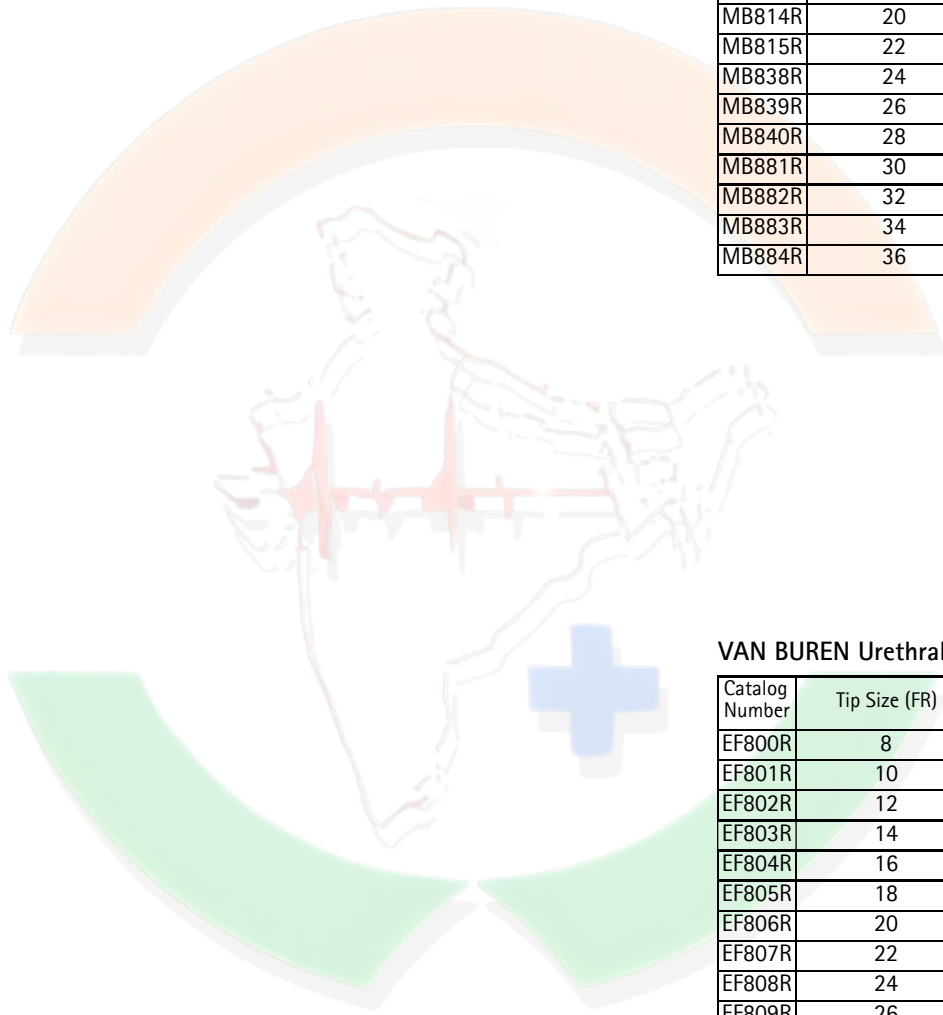

VAN BUREN Urethral Sound

Catalog Number	Tip Size (FR)	Length (in.)
EF800R	8	10 5/8
EF801R	10	10 5/8
EF802R	12	10 5/8
EF803R	14	10 5/8
EF804R	16	10 5/8
EF805R	18	10 5/8
EF806R	20	10 5/8
EF807R	22	10 5/8
EF808R	24	10 5/8
EF809R	26	10 5/8
EF810R	28	10 5/8
EF811R	30	10 5/8
EF812R	32	10 5/8
EF813R	34	10 5/8
EF814R	36	10 5/8
EF815R	38	10 5/8
EF816R	40	10 5/8



EF800R-EF816R





UROLOGY CATHETERS



MB158R-MB169R

WALTHER Dilator-Catheter

Catalog Number	Tip Size (FR)	Length (in.)
MB158R	12	5 1/4
MB170R	14	5 1/4
MB173R	16	5 1/4
MB159R	18	5 1/4
MB160R	20	5 1/4
MB161R	22	5 1/4
MB162R	24	5 1/4
MB163R	26	5 1/4
MB164R	28	5 1/4
MB165R	30	5 1/4
MB166R	32	5 1/4
MB167R	34	5 1/4
MB168R	36	5 1/4
MB169R	38	6

OTIS Bougies a Boule, Olive Tip

Catalog Number	Tip Size (FR)	Length (in.)
MG111R	8	10
MG112R	10	10
MG113R	12	10
MG114R	14	10
MG115R	16	10
MG116R	18	10
MG117R	20	10
MG118R	22	10
MG119R	24	10
MG120R	26	10
MG121R	28	10
MG122R	30	10
MG123R	32	10
MG124R	34	10
MG125R	36	10
MG126R	38	10
MG127R	40	10



MG111R-MG127R

